

Table of Contents / Merchandisers

Displays / Merchandisers	2-6
Tru-Flate POP Die Cut Card	7
Plug & Coupler Design Identification	8
Plug & Coupler Features	9
Plugs & Couplers	10-22
Tire Gauges	23-25
Inflator Gauges	26-27
Air Line Chucks	28-29
Blowguns	30-33
Hose Fittings	34-37
Air Line Hook-Up Hints	38-39
Tru-Flate® Filters, Regulators & Lubricators ...	40-43
In-Line Air Tools	44-45
Amflo® Filters, Regulators & Lubricators	46-50
Air Accessories	51-53
Hose Crimpers & Ferrules	54-55
Tire Repair Products	56-66

Tru-Flate® packaging combines colorful, eye-catching graphics and essential “how-to-use” information for added value to customers. Tru-Flate displays are versatile, with interchangeable headers, moveable hooks and pre-printed back-up cards.

4-Panel Display

96-650 Tru-Flate's most popular air line accessories and tire hardware conveniently mounted on 4 display panels. Free standing display swivels for space efficiency, easy product selection and restocking. Includes Coupler Test Bar for easy in-store identification of coupler and plug design style.

Couplers & Plugs

96-650-10 (Panel 1)

Tru-Flate® Couplers & Plugs					
96-901	13-201	13-225	13-235	13-775	13-537
	12-229	12-239	12-225	12-235	12-527
	13-101	13-125	13-135	13-611	13-613
	12-127	12-125	12-135	12-603	12-605
	12-137	13-511	13-335	12-325	12-335
	13-713	12-705	13-435	12-425	12-435

Part #	Qty.	Description
13-201	3	COUPLER/PLUG SET,1/4" I/M
13-225	2	COUPLER,1/4" I/M,1/4" MNPT
13-235	3	COUPLER,1/4" I/M,1/4" FNPT
13-755	2	PUSH COUPLER,1/4" I/M,1/4" FNPT
13-537	1	COUPLER,3/8" I/M,3/8" FNPT
12-229	3	PLUG,1/4" I/M SWIVEL,1/4" MNPT
12-239	2	PLUG,1/4" I/M SWIVEL,1/4" FNPT
12-225	3	PLUG,1/4" I/M,1/4" MNPT
12-235	2	PLUG,1/4" I/M,1/4" FNPT
12-527	1	PLUG,3/8" I/M,3/8" MNPT
13-101	3	COUPLER/PLUG SET,1/4" T-F
13-125	2	COUPLER,1/4" T-F,1/4" MNPT
13-135	3	COUPLER,1/4" T-F,1/4" FNPT
13-611	1	COUPLER,3/8" T-F,1/4" FNPT
13-613	1	COUPLER,3/8" T-F,3/8" FNPT
12-127	3	PLUG,1/4" T-F SWIVEL,1/4" MNPT
12-125	3	PLUG,1/4" T-F,1/4" MNPT
12-135	2	PLUG,1/4" T-F,1/4" FNPT
12-603	1	PLUG,3/8" T-F,1/4" MNPT
12-605	1	PLUG,3/8" T-F,3/8" MNPT
12-137	2	PLUG,1/4" T-F SWIVEL,1/4" FNPT
13-511	2	COUPLER,UNIVERSAL,1/4" FNPT
13-335	2	COUPLER,1/4" ARO,1/4" FNPT
12-325	3	PLUG,1/4" ARO,1/4" MNPT
12-335	2	PLUG,1/4" ARO,1/4" FNPT
13-713	1	COUPLER,1/2" T-F&I/M,1/2" FNPT
12-705	1	PLUG,1/2" T-F,1/2" MNPT
13-435	2	COUPLER,1/4" LINC,1/4" FNPT
12-425	3	PLUG,1/4" LINC,1/4" MNPT
12-435	2	PLUG,1/4" LINC,1/4" FNPT
96-901	1	COUPLER TEST BAR

Blowguns & Tire Hardware

96-650-11 (Panel 2)

Tru-Flate® Blowguns & Tire Hardware				
17-509	17-519	17-521	17-525	17-545
17-527	17-529	18-247		
17-539		17-551	18-203	18-207
41-125	41-135	18-233	18-237	18-603

Part #	Qty.	Description
17-509	3	GAUGE,TIRE-STANDARD,10-50 PSI
17-519	2	GAUGE,TIRE-TRUCK,20-120 PSI
17-521	1	GAUGE,TIRE-LOW PRESSURE,1-20 PSI
17-525	1	GAUGE,TIRE-TRUCK,DUAL FT 20-120 PSI
17-545	2	GAUGE,TIRE-DUAL FT SRVC,10-150 PSI
17-527	2	GAUGE,TIRE-BICYCLE,20-120 PSI
17-529	3	GAUGE,TIRE-CAR,ECONOMY,10-50 PSI
18-247	2	BLOWGUN,PALM-STYLE KIT
17-539	1	GAUGE,TIRE-DIGITAL,5-150 PSI
17-551	2	GAUGE,TIRE-DIAL,10-60 PSI
18-203	1	BLOWGUN,STANDARD-LEVER TYPE
18-207	2	BLOWGUN,STANDARD-RUBBER TIP
41-125	2	AIRLINE MANIFOLD,3-IN-ONE,1/4"
41-135	2	AIRLINE REGULATOR W/GAUGE
18-233	2	BLOWGUN,SAFETY,LEVER TYPE
18-237	1	BLOWGUN,SAFETY,TAMPER-PROOF
18-603	1	BLOWGUN,ADJUSTABLE,I/M

4-Panel Display Cont.

96-650 Tru-Flate's most popular air line accessories and tire hardware conveniently mounted on 4 display panels. Free standing display swivels for space efficiency, easy product selection and restocking. Includes Coupler Test Bar for easy in-store identification of coupler and plug design style.

Part #	Qty.	Description
17-351	2	CHUCK,BALL FOOT,DIRECT AIRLINE
17-353	2	CHUCK,BALL FOOT,DIRECT AIRLINE W/CLIP
17-383	2	CHUCK, DIRECT AIRLINE, DUAL FOOT
17-395	2	CHUCK,DUAL LOCKING STRAIGHT-ON
17-850	1	INFLATOR GAUGE, DUAL FOOT CHUCK
17-369	2	CHUCK, BALL FOOT, DIRECT, 1/4" MNPT
41-101	1	IN-LINE TOOL OILER
21-123	2	FITTING, BARB, 1/4" ID X 1/4" MNPT
21-133	2	FITTING, BARB, 5/16" ID X 1/4" MNPT
21-143	2	FITTING, BARB, 3/8" ID X 1/4" MNPT
21-147	2	FITTING, BARB, 3/8" ID X 3/8" MNPT
21-323	2	FITTING, SWIVEL, 1/4" ID X 1/4" FNPS
21-423	2	HOSE SPLICER, 1/4" ID
21-467	2	HOSE SPLICER, 3/8" ID
21-505	2	COUPLING, 1/4" MNPT X 1/4" MNPT
23-403	1	FAST STOR HOSE W/ FITTINGS, 25', 1/4"
21-515	2	COUPLING, 1/4" FNPT X 1/4" FNPT
21-535	2	BUSHING, 1/4" FNPT X 3/8" MNPT
21-557	2	DRAIN COCK, 1/4"
41-300	1	HOSE REPAIR KIT
21-605	2	AIRLINE SWIVEL, 1/4" MNPT X 1/4" FNPT
21-707	2	SAFETY VALVE, 1/4", 125 PSI
22-123	2	REUSABLE FITTING, 1/4" MNPT X 19/32" OD

Chucks, Fittings & Gauges

96-650-12 (Panel 3)

Tru-FLATE Chucks, Fittings & Gauges Tru-FLATE				
17-351	17-353	17-383	17-395	17-850
17-369	41-101			
21-123	21-133	21-143	21-147	
21-323	21-423	21-467	21-505	4-25E-RET
21-515	21-535	21-557	41-300	
21-605	21-707	22-123		

Part #	Qty.	Description
38-505	2	PLASTIC VALVE CAP,VC8
38-600-4	2	SCREWDRIVER TYPE VALVE CAP,VC2
38-712-4	2	HEX VALVE CAP
38-772-4	2	DOME TYPE CAP,VC3
38-790-4	2	VALVE CORE,C-1
38-900	2	TANK VALVE,1/8"MNPT
38-324-4	2	PLASTIC VALVE EXTENSION,3/4"
38-325-4	2	PLASTIC VALVE EXTENSION,1-1/4"
38-326-4	2	PLASTIC VALVE EXTENSION,1-1/2"
38-315-4	2	VALVE EXTENSION,1-1/4"
30-413-2	2	SNAP-IN VALVE,TR413
30-414-2	2	SNAP-IN VALVE,TR414
30-415-2	2	SNAP-IN VALVE,TR415
30-418-2	2	SNAP-IN VALVE,TR418
30-445	2	HIGH PERFORMANCE TIRE VALVE
30-316-4	2	CHROME VALVE SLEEVES,TR413
12-077	3	UNIVERSAL CEMENT,2 OZ
14-130	3	TUBE TIRE REPAIR KIT
15-165	3	RADIAL REPAIR KIT
15-169	3	PERMA-STRIP PATCH
41-067	2	TIRE VALVE REPAIR TOOL
14-134	3	FOIL BACK REPAIR KIT
17-236	2	YELLOW TIRE MARKING CRAYON
40-395	1	TREAD DEPTH GAUGE
41-466	1	VALVE FISHING TOOL
15-162	2	SUPER-GRIP TIRE REPAIR KIT

Tire Maintenance Center

96-650-13 (Panel 4)

Tru-FLATE Tire Maintenance Center Tru-FLATE				
38-505	38-600-4	38-712-4	38-772-4	38-790-4
38-900	38-324-4	38-325-4	38-326-4	38-315-4
30-413-2	30-414-2	30-415-2	30-418-2	30-445
30-316-4	12-077	14-130	15-165	15-169
41-067				
14-134	17-236	40-395	41-466	15-162

Merchandisers / Displays

Tire Repair Display

96-213

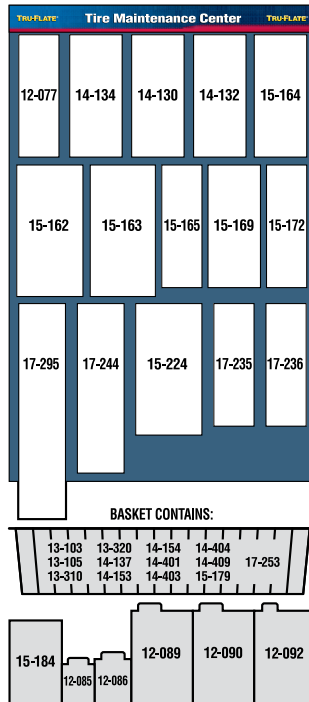

All of the most popular tire repair products in one display. Includes all of the top selling patches, repair tools and cements.

Part # Qty. Description

PEGGED ITEMS

12-077	1	UNIVERSAL CEMENT,2 OZ
14-134	1	FOIL BACK REPAIR KIT
14-130	1	TUBE TIRE REPAIR KIT
14-132	1	DIY TIRE REPAIR KIT
15-164	1	EMERGENCY REFILL KIT (FOR 15-163)
15-162	1	SUPER-GRIP TIRE REPAIR KIT
15-163	1	EMERGENCY TIRE REPAIR KIT
15-165	1	RADIAL REPAIR KIT
15-169	1	PERMA-STRIP PATCH
15-172	1	OPEN-EYE REPAIR NEEDLE
17-295	1	COTTON APPLICATOR SWAB
17-244	1	PROF STITCHER,1/14"FACE X 1-1/2"
15-224	1	SUPER-GRIP OPEN-EYE NEEDLE
17-235	1	WHITE TIRE LETTERING STICK
17-236	1	YELLOW TIRE MARKING CRAYON

BASKET ITEMS - NO POSITION ASSIGNED

13-103	1	TIRE REPAIR BOOT,4-1/2"
13-105	1	TIRE REPAIR BOOT,6"
13-310	1	RADIAL REPAIR UNIT,2-1/4"X3"
13-320	1	RADIAL REPAIR UNIT,3"X4-1/8"
14-137	1	RADIAL PATCH,2-1/4"
14-153	1	BIAS PLY PATCH,2-1/4"
14-154	1	BIAS PLY PATCH,3-1/8"
14-401	1	FOIL BACK PATCH,1-1/2"
14-403	1	FOIL BACK PATCH,2-1/8"
14-404	2	FOIL BACK PATCH,3-1/8"
15-179	1	PERMA-STRIP PATCH
17-253	12	YELLOW TIRE CRAYONS,12 PK

SHELF ITEMS - NO POSITION ASSIGNED

15-184	1	4"RADIAL INSERTS
12-085	1	UNIVERSAL CEMENT,4 OZ
12-086	1	UNIVERSAL CEMENT,8 OZ
12-089	1	UNIVERSAL CEMENT,1 QT
12-090	1	BEAD SEALER,1 QT
12-092	1	LIQUID BUFFER/CLEANER,1 QT

Air Accessory Display

96-640

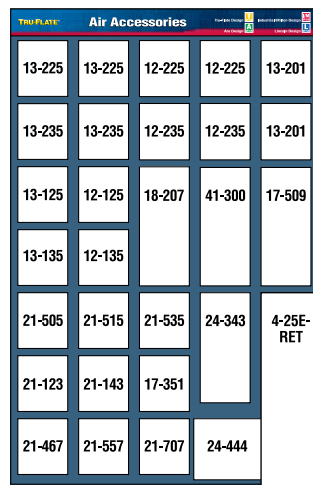

A one panel display that includes many of the top selling SKUs in the Tru-Flate® line, including 25' and 50' Amflo® PVC hoses.

Part # Qty. Description

13-225	6	COUPLER,1/4"1/M,1/4"MNPT
12-225	6	PLUG,1/4"1/M,1/4"MNPT
13-201	6	COUPLER/PLUG SET,1/4"1/M
13-235	6	COUPLER,1/4"1/M,1/4"FNPT
12-235	6	PLUG,1/4"1/M,1/4"FNPT
13-125	4	COUPLER,1/4"1/M,1/4"MNPT
12-125	4	PLUG,1/4"1/M,1/4"MNPT
18-207	2	BLOWGUN,STANDARD-RUBBER TIP
41-300	2	HOSE REPAIR KIT
17-509	5	GAUGE,TIRE-STANDARD,10-50 PSI
13-135	4	COUPLER,1/4"1/M,1/4"FNPT
12-135	4	PLUG,1/4"1/M,1/4"FNPT
21-505	2	COUPLING,1/4"MNPTX1/4"MNPT
21-515	2	COUPLING,1/4"FNPTX1/4"FNPT
21-535	2	BUSHING,1/4"FNPTX3/8"MNPT
24-343	1	FILTER,MINI
4-25E-RET	1	FAST STOR HOSE W/FITTINGS,25',1/4"
21-123	2	FITTING,BARB,1/4"IDX1/4"MNPT
21-143	2	FITTING,BARB,3/8"IDX1/4"MNPT
17-351	2	CHUCK,BALL FOOT,DIRECT AIRLINE
21-467	2	HOSE SPLICER,3/8"ID
21-557	2	DRAIN COCK,1/4"
21-707	2	SAFETY VALVE,1/4",125PSI
24-444	1	REGULATOR,MINI
576-25A	3	PVC HOSE 3/8"x25'w-1/4"FTNGS,ORANGE
576-50A	3	PVC HOSE 3/8"x50'w-1/4"FTNGS,ORANGE



Merchandisers / Displays

96-610 Includes 96-610-02 and 96-610-03.

Purchase both panels for the widest, most complete range of tire hardware and air accessories, or order a single panel for key products.

Includes tire gauges, tire patching materials and the most popular tire extensions, caps, cores and sleeves.

Part #	Qty.	Description
17-509	3	TIRE GAUGE, STANDARD
17-515	3	TIRE GAUGE, RADIAL
17-519	3	TIRE GAUGE, TRUCK
17-525	3	TIRE GAUGE, TRUCK, DUAL FOOT
17-545	2	TIRE GAUGE, DUAL FOOT SERVICE
14-134	3	FOIL BACK REPAIR KIT
14-130	3	TUBE TIRE REPAIR KIT
17-527	3	TIRE GAUGE, BICYCLE
17-551	3	TIRE GAUGE, DIAL
15-165	3	RADIAL REPAIR KIT
15-169	3	PERMA-STRIP PATCH
38-505	3	PLASTIC VALVE CAP, PVC8
38-600-4	3	VALVE CAP, SCREWDRIVER TYPE
38-712-4	3	HEX VALVE CAP
30-318-4	3	CHROME VALVE SLEEVES
38-790-4	3	VALVE CORE, TR C-1
41-067	3	TIRE VALVE REPAIR TOOL
38-324-4	3	PLASTIC VALVE EXTENSIONS, 3/4"
38-325-4	3	PLASTIC VALVE EXTENSION, 1-1/4"
38-326-4	3	PLASTIC VALVE EXTENSION, 1-1/2"
38-314-4	3	VALVE EXTENSION, 3/4"
38-315-4	3	VALVE EXTENSION, 1-1/4"

Tire Maintenance Center

96-610-02

Tire Maintenance Center				
17-509	17-515	17-519	17-525	17-545
14-134	14-130	17-527	17-551	
15-165	15-169	38-505	386004	387124
		303184	387904	41-067
383244	383254	383264	383144	383154

Covers all four common pneumatic coupler and plug designs, popular brass fittings and air line chucks, blowguns and coiled air hose.

Part #	Qty.	Description
12-125	3	TRU-FLATE DESIGN NIPPLE
12-225	3	INDUSTRIAL/MILTON DESIGN NIPPLE
12-325	3	ARO DESIGN NIPPLE
12-425	3	LINCOLN DESIGN NIPPLE
13-101	3	TRU-FALT DESIGN COUPLER SET
13-135	3	TRU-FLATE DESIGN COUPLER
13-201	3	INDUSTRIAL/MILTON DESIGN COUPLER SET
13-235	3	INDUSTRIAL/MILTON DESIGN COUPLER
13-335	3	ARO DESIGN COUPLER
13-435	3	LINCOLN DESIGN COUPLER
17-351	3	DIRECT AIR LINE CHUCK
17-383	3	DIRECT AIR LINE CHUCK
18-203	2	LEVER TYPE BLOWGUN
18-233	2	SAFETY BLOWGUN
18-601	2	TRU-FLATE DESIGN ADJUSTABLE BLOWGUN
18-603	2	INDUSTRIAL/MILTON DESIGN ADJUSTABLE BLOWGUN
21-123	3	BARBED HOSE FITTING
21-143	3	BARBED HOSE FITTING
21-423	3	BARBED HOSE SPLICER
22-123	3	REUSABLE HOSE FITTING
4-25E-RET	1	FAST STOR HOSE
41-101	1	AIR TOOL OILER
41-300	2	AIR HOSE REPAIR KIT
96-901	1	COUPLER TEST BAR

Air Accessories

96-610-03

Air Accessories				
13-101	12-125	13-135	12-325	13-335
13-201	12-225	13-235	12-425	13-435
17-351	21-123	21-143	21-423	22-123
4-25E-RET	18-233	18-203	18-601	18-603
	41-101	41-300	17-383	

Merchandisers / Displays

96-630 Includes 96-630-02 and 96-630-03.

Purchase both panels for the widest, most complete range of couplers, plugs, chucks, fittings and gauges or order a single panel for key products.

Couplers & Plugs

96-630-02

Couplers & Plugs				
13-101	13-125	13-135	12-125	12-135
13-201	13-225	13-235	12-225	12-235
13-301	13-325	13-335	12-325	12-335
13-401	13-425	13-435	12-425	12-435
13-611	13-613	12-603	12-605	12-705
13-713	13-755	13-537	12-527	13-511

Most popular sizes of Tru-Flate, Lincoln, I/M, and Aro couplers and plugs.

Part #	Qty.	Description
12-125	2	NIPPLE, 1/4" T-F, 1/4" MNPT
12-135	2	NIPPLE, 1/4" T-F, 1/4" FNPT
12-225	2	NIPPLE, 1/4" I/M, 1/4" MNPT
12-235	2	NIPPLE, 1/4" I/M, 1/4" FNPT
12-325	2	NIPPLE, 1/4" ARO, 1/4" MNPT
12-335	2	NIPPLE, 1/4" ARO, 1/4" FNPT
12-425	2	NIPPLE, 1/4" LINCOLN, 1/4" MNPT
12-435	2	NIPPLE, 1/4" LINCOLN, 1/4" FNPT
12-527	2	NIPPLE, 3/8" I/M, 3/8" MNPT
12-603	2	NIPPLE, 3/8" T-F, 1/4" MNPT
12-605	2	NIPPLE, 3/8" T-F, 3/8" MNPT
12-705	2	NIPPLE, 1/2" T-F, 1/2" MNPT
13-101	2	COUPLER/NIPPLE SET, 1/4" T-F
13-125	2	COUPLER, 1/4" T-F, 1/4" MNPT
13-135	2	COUPLER, 1/4" T-F, 1/4" FNPT
13-201	2	COUPLER/NIPPLE SET, 1/4" I/M
13-225	2	COUPLER, 1/4" I/M, 1/4" MNPT
13-235	2	COUPLER, 1/4" I/M, 1/4" FNPT
13-301	2	COUPLER/NIPPLE SET, 1/4" ARO
13-325	2	COUPLER, 1/4" ARO, 1/4" MNPT
13-335	2	COUPLER, 1/4" ARO, 1/4" FNPT
13-401	2	COUPLER/NIPPLE SET, 1/4" LINCOLN
13-425	2	COUPLER, 1/4" LINCOLN, 1/4" MNPT
13-435	2	COUPLER, 1/4" LINCOLN, 1/4" FNPT
13-511	1	COUPLER, UNIVERSAL, 1/4" FNPT
13-537	2	COUPLER, 3/8" I/M, 3/8" FNPT
13-611	2	COUPLER, 3/8" T-F, 1/4" FNPT
13-613	2	COUPLER, 3/8" T-F, 3/8" FNPT
13-713	2	COUPLER, 3/8" T-F, 1/2" FNPT
13-755	2	PUSH COUPLER, 1/4" I/M, 1/4"
96-901	1	COUPLER TEST BAR

Blowguns, Chucks & Fittings

96-630-03

Blowguns, Chucks & Fittings				
21-123	21-133	21-143	21-147	17-850
21-323	21-423	21-467	21-505	
21-515	21-535	21-605	17-351	
17-353	17-383	18-603	41-125	17-373
17-361				4-25E-RET
18-203	18-233	18-207	17-385	

Most popular air hose fittings, chucks, blowguns.

Part #	Qty.	Description
21-123	2	FITTING,BARB,1/4"IDx1/4"MNPT
21-133	2	FITTING,BARB,5/16"IDx1/4"MNPT
21-143	2	FITTING,BARB,3/8"IDx1/4"MNPT
21-147	2	FITTING,BARB,3/8"IDx3/8"MNPT
17-850	2	GAUGE,INFLATOR-DELUXE
21-323	2	FITTING,HOSE-SWIVEL,FEMALE
21-423	2	HOSE SPLICER,1/4"ID
21-467	2	HOSE SPLICER,3/8"ID
21-505	2	COUPLING,1/4"MNPTx1/4"MNPT
21-515	2	COUPLING,1/4"FNPTx1/4"FNPT
21-535	2	BUSHING,1/4"FNPTx3/8"MNPT
21-603	2	AIRLINE SWIVEL,1/4"MNPTx3/8"
21-605	2	AIR SWIVEL,1/4"MNPTx1/4"FNPT
17-351	2	CHUCK,DIRECT AIRLINE
17-353	2	CHUCK,DIRECT AIRLINE W/CLIP
17-383	2	CHUCK,DIRECT AIRLINE,DUAL FOOT
18-603	2	BLOWGUN,ADJUSTABLE I/M
17-373	2	CHUCK,GRIP-TITE
17-355	2	CHUCK,SNAP-ON W/CLIP
41-101	2	IN-LINE TOOL OILER
4-25E-RET	2	HOSE W/FTGS,25"-FAST STORE
18-203	2	BLOWGUN,STANDARD-LEVER
18-233	2	BLOWGUN,SAFETY-LEVER
18-207	2	BLOWGUN,STANDARD-RUBBER TIP
41-125	2	AIRLINE MANIFOLD,3-IN-ONE,1/4"

Tru-Flate® Patent Pending POP Die-Cut Card

- Part number **99-001**
- Reduce confusion and frustration - try the plug on die-cut card before purchase
- Cards are supplied FREE from Tru-Flate (25 Per-Pack)
- Consumers can keep the card and mark the style coupler/plug they have



New Tru-Flate® packaging

- Tru-Flate offers innovative, patent pending die-cut packaging to aid in selection process
 - Plug outline template built into card to compare profiles
 - Reduces confusion for end-user
- Tire repair and air accessories packages are coordinated to give strong, unmistakable family appearance at retail.
- Includes Milton part number



Design Identification

How to Identify Interchange Designs

Interchangeability of pneumatic couplings is determined by PLUG DESIGN. Learn to identify the basic plug types, and coupler and plug interchange will become easy. There are SEVEN different designs currently used in the automotive market. Four of these seven cover more than 97% of all quick couplings used today. Amflo® and Tru-Flate® provide complete interchange to the four primary designs.

Tru-Flate Design 12/13-100 Series

This design is easily recognized because it has the shortest plug pilot in the industry; however, it has the widest metal section between the ball groove and the pilot. In addition, the sealing surface on the end of the plug is wider than other “interchange” designs. This design provides better sealing characteristics and longer seal life.

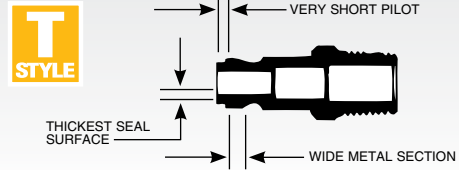

Industrial/Milton Design 12/13-200 Series

This design has been adopted by many coupler manufacturers, including Milton, Hansen, ARO, Lincoln and Schrader. It will work with either “sleeve” type or “push” type couplers. No matter what the coupler looks like, if it mates with this plug, it is an “Industrial/Milton Interchange” design. It can be identified by its 3/16" pilot and its flat-bottomed V-shaped ball groove. Conforms to ANSI (NFPA) T3.20.14-1990 dimensions.

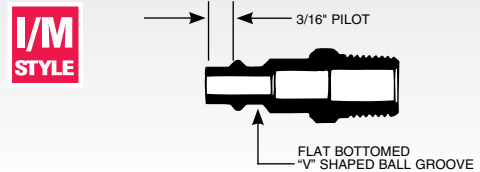

ARO Design 12/13-300 Series

This design is characteristic of the ARO 210 series, and requires a coupler of proper matching design. Although similar in appearance to the “Industrial/Milton Interchange” design, it can be easily distinguished because its pilot is 1/8" longer and its ball groove is nearly round.

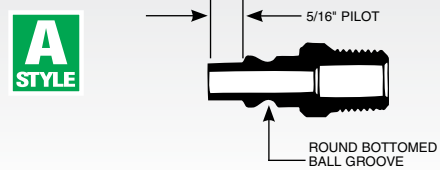

Lincoln Design 12/13-400 Series

The “Lincoln long-stem” design is the most easily identified design. The long 3/4" pilot is so distinctive it cannot be confused with other designs. It will only mate with couplers of matching design and size.

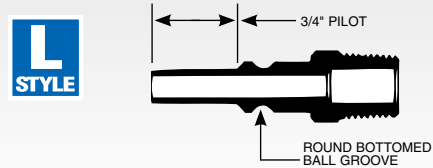

Other Designs

SCHRADER STANDARD

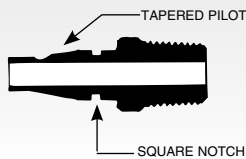

DIAMOND-U

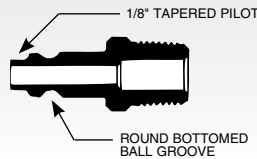

GRACO

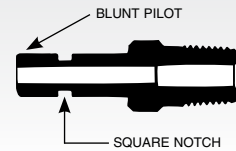

How to Interchange Couplers and Plugs

Design Selection

Similar name designs, whether manufactured by Amflo, Tru-Flate or a competitor, are interchangeable. NOTE: Designs are **not interchangeable** with other designs.

Size Selection

There are three BODY SERIES sizes – Standard 1/4" and Heavy Duty 3/8" and 1/2". To interchange, the coupler and plug must have the same body size.

Plug & Coupler Features

Construction Advantages

Unique performance features makes Amflo and Tru-Flate couplings work better and last longer, providing **100% RELIABILITY**

Greater Air Flow: Amflo and Tru-Flate's tubular valve construction passes more air at lower pressure drops than competitive blade or knife type valve designs.

100% Air-Tight Seal: Our spring-loaded, air-assisted valve design strengthens coupler seal as line pressure is increased. Extra locking carbon steel ball bearings provide a tighter fit and accurate alignment for superior performance.

Accidental Disconnect Protection: Amflo and Tru-Flate's sleeve guard reduces the potential for accidental disconnect and protects the sleeve under the toughest working conditions.

Lasts Longer: Prolonged seal life due to the tubular valve support, thus preventing the seal from moving into the air flow path. Eliminates the wear and damage that occurs with competitive blade or knife type valves.

TUBULAR VALVE - LONGER SEAL LIFE

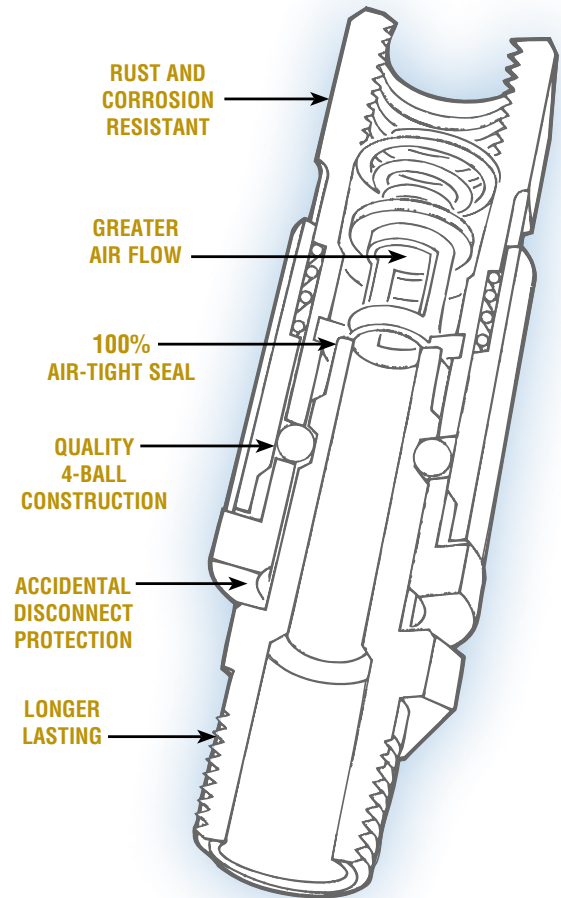
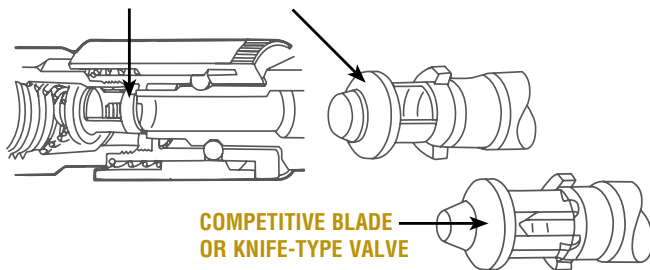

Coupler / Plug Key Ring

These sturdy key rings are among the finest available. Similar to 1/8" pneumatic coupler and plug sets with steel construction and heavy nickel plating. Will provide years of reliable service and security.

900D Carded. 10/master.

900-10 10/box.

900-100 Bulk. 100/box.



Coupler / Plug Test Bars

Makes coupler and plug sales easy. Gives counter men a "surefire" way to quickly and accurately identify the proper 1/4" series plug for their coupler. Metal bar has each of four basic design plugs permanently fastened to the bar. Color-coded plugs on bar match correct coupler and plug package. Each design name is stamped in bar. Complete with handy hanger strap.

96-901 Coupler Test Bar. 1/bag.

96-902 Plug Test Bar. 1/bag.



T-Style® Design

(One Narrow Band on Coupler Body)

The Tru-Flate Design Plug is recognized by the extremely short pilot; however, it has the widest metal section between the groove and the pilot. The sealing surface on the end of the plug is wider than other interchanges, resulting in better sealing and longer seal life. The Tru-Flate Design Coupler utilizes the tubular valve which supports the seal and allows more air flow at lower pressure drops than most competitive couplers. The protective collar guards against accidental disconnect.

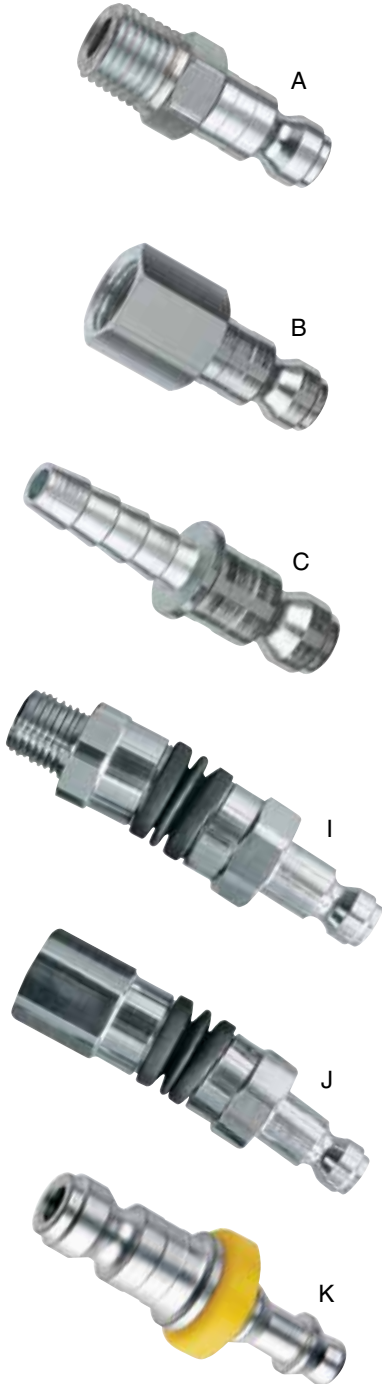

Thread	NPT	Style	Metal	Tru-Flate	Quantity	Amflo	Quantity
1/4" Body Series – Plugs							
Male	1/4"	A	Steel	12-124	10/box	CP1	10/box
Male	1/4"	A	Steel	12-124-07	250/box	CP1-100	100/box
Male	1/4"	A	Steel	12-125	10/master*	CP1-RET	5/master*
Swivel M	1/4"	I	Steel	12-127	5/master*	–	–
Male	1/4"	A	Brass	–	–	CP1B	10/box
Male	3/8"	A	Steel	–	–	CP1-03	10/box
Male	.302-32	A	Steel	–	–	CP1-302	10/box
Female	1/4"	B	Steel	12-134	10/box	CP2	10/box
Female	1/4"	B	Steel	12-134-07	250/box	CP2-100	100/box
Female	1/4"	B	Steel	12-135	10/master*	–	–
Swivel F	1/4"	J	Steel	12-137	5/master*	–	–
Female	1/4"	B	Brass	–	–	CP2B	10/box
Female	3/8"	B	Steel	–	–	CP2-23	10/box
Hose Barb	1/4"	C	Steel	12-117	10/master*	–	–
Hose Barb	1/4"	C	Steel	–	–	CP1-42	10/box
Hose Barb	3/8"	C	Steel	–	–	CP1-44	10/box
Lock-On	1/4"	K	Steel	–	–	CP1-42L	10/box
Lock-On	3/8"	K	Steel	–	–	CP1-44L	10/box

*Carded display package

WARNING: Due to their large size, these couplers should not be connected or disconnected if the line pressure exceeds 40 PSI.

WARNING: Couplers and plugs are intended for use on compressed air lines only. All have maximum rated working pressure of 300 PSI.

Thread	NPT	Style	Metal	Tru-Flate	Quantity	Amflo	Quantity
1/4" Body Series – Couplers							
Male	1/4"	D	Brass	13-124	10/box	C1B	10/box
Male	1/4"	D	Brass	13-125	10/master*	–	–
Male	1/4"	D	Brass	–	–	C1B-100	100/box
Male	1/4"	D	Steel	–	–	C1	10/box
Male	1/4"	D	Steel	–	–	C1-100	100/box
Male	1/4"	D	Steel	–	–	C1-RET	5/master*
Male	3/8"	D	Steel	–	–	C1-03	100/box
Female	1/4"	E	Brass	13-134	10/box	C2B	10/box
Female	1/4"	E	Brass	13-134-07	100/box	C2B-100	100/box
Female	1/4"	E	Brass	13-135	10/master*	–	–
Female	1/4"	M	Brass	13-137	5/master*	–	–
Female	1/4"	E	Steel	–	–	C2	10/box
Female	1/4"	E	Steel	–	–	C2-25	25/box
Female	1/4"	E	Steel	–	–	C2-100	100/box
Female	1/4"	E	Steel	–	–	C2-RET	5/master*
Female	3/8"	E	Steel	–	–	C2-23	10/box
Female	3/8"	E	Brass	13-138	10/box	–	–
Hose Barb	1/4"	F	Steel	–	–	C2-42	10/box
Hose Barb	3/8"	F	Steel	–	–	C2-44	10/box
Hose Barb	3/8"	F	Brass	–	–	C2-44B	10/box
Lock-On	1/4"	L	Steel	–	–	C2-42L	10/box
Lock-On	3/8"	L	Steel	–	–	C2-44L	10/box

Plug/Coupler Set							
One each of Tru-Flate 13-135 and 12-125				13-101	10/master*	–	–

*Carded display package

T-Style® Design

(One Narrow Band on Coupler Body)



D



E



M



F



L

WARNING: Due to their large size, these couplers should not be connected or disconnected if the line pressure exceeds 40 PSI.

WARNING: Couplers and plugs are intended for use on compressed air lines only. All have maximum rated working pressure of 300 PSI.

T-Style® Design

(One Narrow Band on Coupler Body)

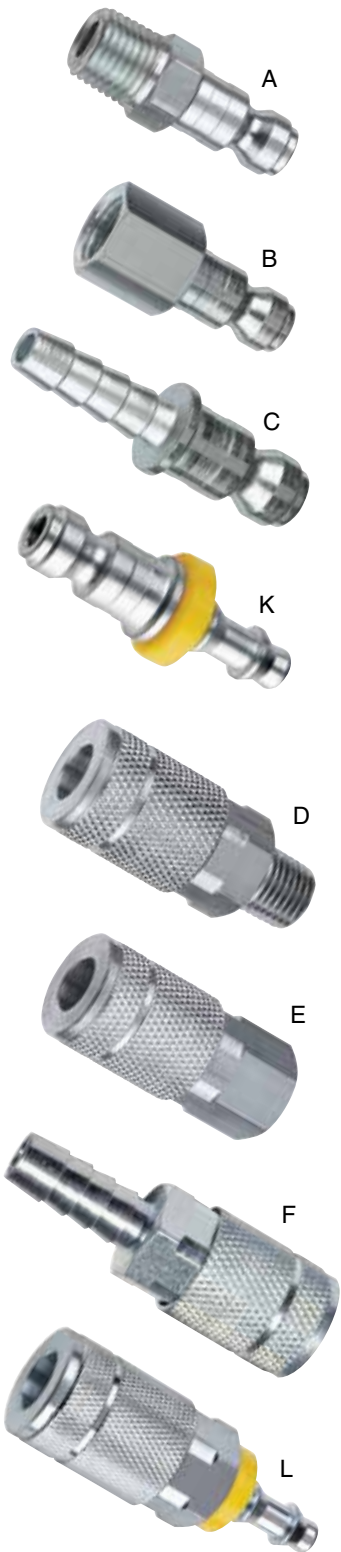

Thread	NPT	Style	Metal	Tru-Flate	Quantity	Amflo	Quantity
3/8" Body Series – Plugs							
Male	1/4"	A	Steel	12-602	10/box	CP7	10/box
Male	1/4"	A	Steel	–	–	CP7-50	50/box
Male	1/4"	A	Steel	12-603	10/master*	–	–
Male	3/8"	A	Steel	12-604	10/box	CP5	10/box
Male	3/8"	A	Steel	–	–	CP5-50	50/box
Male	3/8"	A	Steel	12-605	10/master*	–	–
Male	1/2"	A	Steel	–	–	CP5-04	10/box
Female	1/4"	B	Steel	12-610	10/box	CP8	10/box
Female	1/4"	B	Steel	12-611	10/master*	–	–
Female	1/4"	B	Steel	–	–	CP8-50	50/box
Female	1/4"	B	Steel	–	–	CP8-RET	5/master*
Female	3/8"	B	Steel	12-612	10/box	CP6	10/box
Female	3/8"	B	Steel	12-613	10/master*	–	–
Female	3/8"	B	Steel	–	–	CP6-50	50/box
Female	1/2"	B	Steel	–	–	CP6-24	10/box
Hose Barb	3/8"	C	Steel	–	–	CP5-44	10/box
Lock-On	3/8"	K	Steel	–	–	CP5-44L	10/box
3/8" Body Series – Couplers							
Male	1/4"	D	Steel	13-602	5/box	C7	10/box
Male	1/4"	D	Steel	–	–	C7-50	50/box
Male	1/4"	D	Steel	13-603	5/master	–	5/master*
Male	3/8"	D	Steel	13-604	5/box	C5	10/box
Male	3/8"	D	Steel	13-605	5/master*	–	–
Male	3/8"	D	Steel	–	–	C5-50	50/box
Male	1/2"	D	Steel	–	–	C5-04	10/box
Female	1/4"	E	Steel	13-610	5/box	C8	10/box
Female	1/4"	E	Steel	13-611	5/master*	–	–
Female	1/4"	E	Steel	–	–	C8-50	50/box
Female	3/8"	E	Steel	13-612	5/box	C6	10/box
Female	3/8"	E	Steel	13-613	5/master*	–	–
Female	3/8"	E	Steel	–	–	C6-50	50/box
Female	3/8"	E	Brass	–	–	C6B	10/box
Female	1/2"	E	Steel	–	–	C6-24	10/box
Hose Barb	3/8"	F	Steel	–	–	C6-44	10/box
Hose Barb	1/2"	F	Steel	–	–	C6-45	10/box
Lock-On	3/8"	L	Steel	–	–	C6-44L	10/box

*Carded display package

Thread	NPT	Style	Metal	Tru-Flate	Quantity	Amflo	Quantity
1/2" Body Series – Plugs							
Male	3/8"	A	Steel	12-702	10/box	CP9-03	10/box
Male	1/2"	A	Steel	12-704	10/box	CP9	10/box
Male	1/2"	A	Steel	12-704-07	125/box	–	–
Male	1/2"	A	Steel	–	10/box	–	–
Male	1/2"	A	Steel	12-705	10/master*	–	–
Male	1/2"	A	Steel	–	–	CP9-50	50/box
Female	3/8"	B	Steel	–	–	CP10-23	10/box
Female	1/2"	B	Steel	12-712	10/box	CP10	10/box
Female	1/2"	B	Steel	12-713	5/master*	–	–
Female	1/2"	B	Steel	–	–	CP10-50	50/box
Hose Barb	1/2"	C	Steel	–	–	CP9-45	10/box
1/2" Body Series – Couplers							
Male	3/8"	D	Steel	13-702	5/box	C9-03	10/box
Male	1/2"	D	Steel	13-704	5/box	C9	10/box
Male	1/2"	D	Steel	13-705	5/master*	–	–
Male	1/2"	D	Steel	–	–	C9-50	50/box
Female	3/8"	E	Steel	13-710	5/box	C10-23	10/box
Female	1/2"	E	Steel	13-712	5/box	C10	10/box
Female	1/2"	E	Steel	13-713	5/master*	–	–
Female	1/2"	E	Steel	–	–	C10-50	50/box
Female	1/2"	M	Steel	–	–	C10R	10/box
Hose Barb	1/2"	F	Steel	–	–	C10-45	10/box
Hose Barb	1/2"	F	Steel	–	–	C10-45-50	50/box

Recappers – Plugs (not shown)							
Female	1/4"	–	Steel	–	–	C2R	10/box
Female	1/4"	–	Steel	–	–	C2R-100	100/box
Female	1/4"	–	Brass	–	–	C2RB	10/box
Recappers – Couplers (not shown)							
Female	.302-32	–	Steel	–	–	CP12	10/box

*Carded display package

T-Style® Design

(One Narrow Band on Coupler Body)



WARNING: Due to their large size, these couplers should not be connected or disconnected if the line pressure exceeds 40 PSI.

WARNING: Couplers and plugs are intended for use on compressed air lines only. All have maximum rated working pressure of 300 PSI.

I/M Style Design

(Two Narrow Bands on Coupler Body)

Adopted by most coupler manufacturers, this plug design is considered the industrial standard. It can be identified by the 3/16" pilot and flat bottom V-shaped ball groove. Conforms to ANSI (NFPA) T3.20.14-1990 dimensions. Couplers are available in both standard and push-to-connect style sleeve.

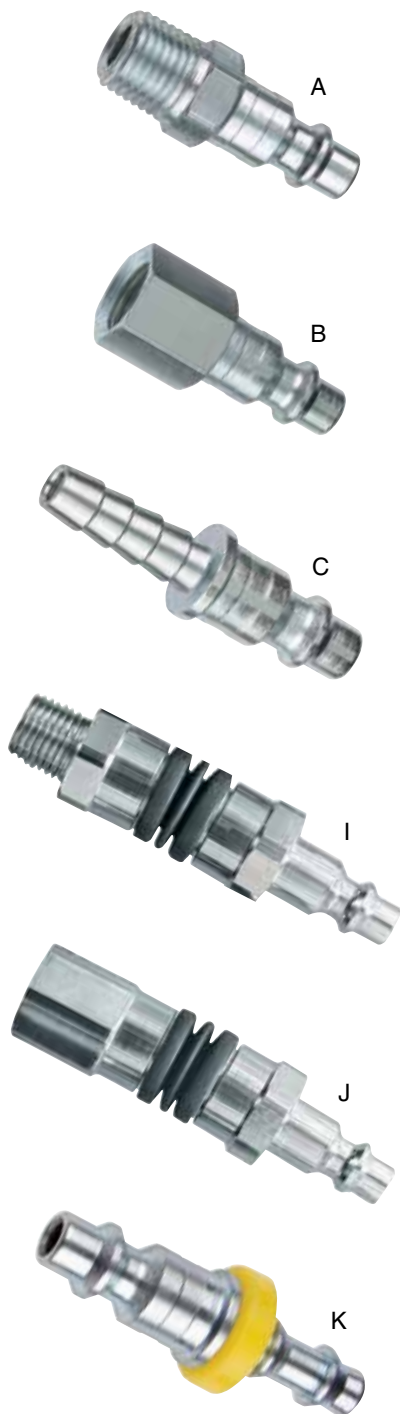

Thread	NPT	Style	Metal	Tru-Flate	Quantity	Amflo	Quantity
1/4" Body Series – Plugs							
Male	1/4"	A	Steel	12-224	10/box	CP21	10/box
Male	1/4"	A	Steel	–	–	CP21-25	25/box
Male	1/4"	A	Steel	12-224-07	250/box	CP21-100	100/box
Male	1/4"	A	Steel	12-225	10/master*	–	–
Swivel M	1/4"	I	Steel	12-229	5/master*	–	–
Male	1/4"	A	Brass	–	–	CP21B	10/box
Male	1/4"	A	Brass	–	–	CP21B-100	100/box
Male	3/8"	A	Steel	12-226	10/box	CP21-03	10/box
Male	3/8"	A	Steel	12-227	10/master*	–	–
Male	3/8"	A	Steel	–	–	CP21-03-100	100/box
Male	3/8"	A	Brass	–	–	CP21-03B	10/box
Female	1/4"	B	Steel	12-234	10/box	CP20	10/box
Female	1/4"	B	Steel	–	–	CP20-25	25/box
Female	1/4"	B	Steel	12-234-07	250/box	CP20-100	100/box
Female	1/4"	B	Steel	12-235	10/master*	–	–
Female	1/4"	B	Steel	–	–	CP20D	5/master*
Swivel F	1/4"	J	Steel	12-239	5/master*	–	–
Female	1/4"	B	Brass	–	–	CP20B	10/box
Female	1/4"	B	Brass	–	–	CP20B-100	100/box
Female	3/8"	B	Steel	12-236	10/box	CP20-23	10/box
Female	3/8"	B	Steel	12-237	10/master*	–	–
Female	.302-32	B	Steel	–	–	CP22	10/box
Hose Barb	1/4"	C	Steel	12-264	10/box	CP21-42	10/box
Hose Barb	1/4"	C	Steel	–	–	CP21-42-100	100/box
Hose Barb	1/4"	C	Steel	12-265	5/master	–	–
Hose Barb	3/8"	C	Steel	12-266	10/box	CP21-44	10/box
Hose Barb	3/8"	C	Steel	–	–	CP21-44-100	100/box
Hose Barb	3/8"	C	Steel	12-267	5/master	–	–
Hose Barb	3/8"	C	Brass	–	–	CP21-44B	10/box
Lock-On	1/4"	K	Steel	–	–	CP21-42L	10/box
Lock-On	1/4"	K	Steel	–	–	CP21-42L-100	100/box
Lock-On	3/8"	K	Steel	–	–	CP21-44L	10/box

*Carded display package

Thread	NPT	Style	Metal	Tru-Flate	Quantity	Amflo	Quantity
1/4" Body Series – Couplers							
Male	1/4"	D	Steel	–	–	C21	10/box
Male	1/4"	D	Steel	–	–	C21-25	25/box
Male	1/4"	D	Steel	–	–	C21-100	100/box
Male	1/4"	D	Brass	13-224	10/box	C21B	10/box
Male	1/4"	D	Brass	13-224-07	100/box	C21B-100	100/box
Male	1/4"	D	Brass	13-225	10/master*	–	–
Male	3/8"	D	Steel	–	–	C21-03	10/box
Male	3/8"	D	Brass	13-226	10/box	C21-03B	10/box
Male	3/8"	D	Brass	13-227	10/master*	–	–
Male	3/8"	D	Brass	–	–	C21-03B-100	100/box
Female	1/4"	E	Steel	–	–	C20	10/box
Female	1/4"	E	Steel	–	–	C20-25	25/box
Female	1/4"	E	Steel	–	–	C20-100	100/box
Female	1/4"	E	Steel	–	–	C20-RET	5/master*
Female	1/4"	E	Brass	13-234	10/box	C20B	10/box
Female	1/4"	E	Brass	–	–	C20B-25	25/box
Female	1/4"	E	Brass	13-234-07	100/box	C20B-100	100/box
Female	1/4"	E	Brass	13-235	10/master*	–	–
Female	3/8"	E	Steel	–	–	C20-23	10/box
Female	3/8"	E	Steel	–	–	C20-23-100	100/box
Female	3/8"	E	Brass	13-236	10/box	C20-23B	10/box
Female	3/8"	E	Brass	13-237	10/master*	–	–
Hose Barb	1/4"	F	Steel	–	–	C20-42	10/box
Hose Barb	1/4"	F	Steel	–	–	C20-42-100	100/box
Hose Barb	1/4"	F	Brass	13-264	10/box	C20-42B	10/box
Hose Barb	1/4"	F	Brass	–	–	C20-42B-100	100/box
Hose Barb	3/8"	F	Steel	–	–	C20-44	10/box
Hose Barb	3/8"	F	Steel	–	–	C20-44-100	100/box
Hose Barb	3/8"	F	Brass	13-266	10/box	C20-44B	10/box
Lock-On	1/4"	L	Steel	–	–	C20-42L	10/box
Lock-On	1/4"	L	Brass	–	–	C20-42LBP-100	100/box
Lock-On	3/8"	L	Steel	–	–	C20-44L	10/box
Lock-On	3/8"	L	Brass	–	–	C20-44LBP-100	100/box

*Carded display package

I/M Style Design

(Two Narrow Bands on Coupler Body)

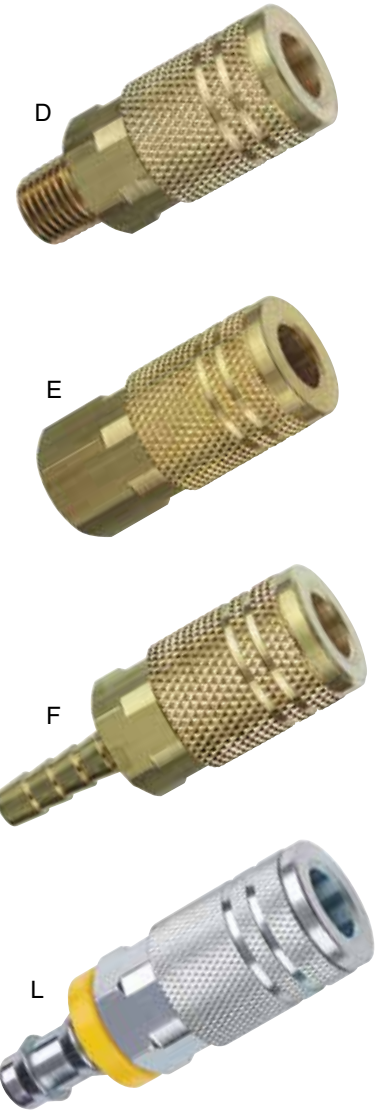

WARNING: Due to their large size, these couplers should not be connected or disconnected if the line pressure exceeds 40 PSI.

WARNING: Couplers and plugs are intended for use on compressed air lines only. All have maximum rated working pressure of 300 PSI.

I/M Style Design

(Two Narrow Bands on Coupler Body)



Thread	NPT	Style	Metal	Tru-Flate	Quantity	Amflo	Quantity
1/4" – Push-To-Connect Couplers							
Male	1/4"	G	Steel	13-756	10/master*	–	–
Male	1/4"	G	Steel	–	–	C41	10/box
Female	1/4"	H	Steel	13-755	10/master*	–	–
Female	1/4"	H	Steel	–	–	C40	10/box
1/4" – Locking Couplers							
Male	1/4"	O	Steel	–	–	C81	10/box
Female	1/4"	P	Steel	–	–	C80	10/box
1/4" – Push-Button Couplers							
Male	1/4"	Q	Steel	–	–	C82	5/master*
Male	3/8"	Q	Steel	–	–	C84	5/master*
Female	1/4"	R	Steel	–	–	C83	5/master*
Female	3/8"	R	Steel	–	–	C85	5/master*
Plug/Coupler Sets							
One each of Tru-Flate 12-225 and 13-235				13-201	10/master*	–	–
One each: 12-225, 12-235, 13-235 and 21-505				13-203	5/master*	–	–
One 13-234, three 12-224 and one 12-234				13-205	5/master*	–	–

3/8" Body Series – Plugs							
Male	1/4"	A	Steel	12-523	5/master*	–	–
Male	1/4"	A	Steel	12-525	5/box	CP25-02	10/box
Male	1/4"	A	Steel	–	–	CP25-02-100	100/box
Male	3/8"	A	Steel	12-526	5/box	CP25	10/box
Male	3/8"	A	Steel	–	–	CP25-50	50/box
Male	3/8"	A	Steel	12-527	5/master*	–	–
Male	1/2"	A	Steel	–	–	CP25-04	10/box
Female	1/4"	B	Steel	12-533	5/master*	–	–
Female	1/4"	B	Steel	–	–	CP26-22	10/box
Female	3/8"	B	Steel	12-536	5/box	CP26	10/box
Female	3/8"	B	Steel	–	–	CP26-50	50/box
Female	3/8"	B	Steel	12-537	5/master*	–	–
Female	1/2"	B	Steel	–	–	CP26-24	10/box
Hose Barb	3/8"	C	Steel	–	–	CP25-44	10/box
Hose Barb	1/2"	C	Steel	–	–	CP25-45	10/box
Lock-On	3/8"	K	Steel	–	–	CP25-44L	10/box

*Carded display package

Thread	NPT	Style	Metal	Tru-Flate	Quantity	Amflo	Quantity
3/8" Body Series – Couplers							
Male	1/4"	D	Steel	–	–	C25-02	10/box
Male	1/4"	D	Steel	13-523	5/master	–	–
Male	3/8"	D	Steel	13-526	5/box	C25	10/box
Male	3/8"	D	Steel	–	–	C25-50	50/box
Male	3/8"	D	Steel	13-527	5/master*	–	–
Male	1/2"	D	Steel	–	–	C25-04	10/box
Female	1/4"	E	Steel	–	–	C26-22	10/box
Female	3/8"	E	Steel	13-536	5/box	C26	10/box
Female	3/8"	E	Steel	–	–	C26-50	50/box
Female	3/8"	E	Steel	13-537	5/master*	–	–
Female	1/2"	E	Steel	–	–	C26-24	10/box
Hose Barb	3/8"	F	Steel	–	–	C26-44	10/box
Hose Barb	1/2"	F	Steel	–	–	C26-45	10/box
Hose Barb	1/2"	F	Steel	–	–	C26-45-50	50/box
Lock-On	3/8"	L	Steel	–	–	C26-44L	10/box

1/2" Body Series – Plugs							
Male	3/8"	A	Steel	12-750	10/box	CP17-03	10/box
Male	1/2"	A	Steel	12-752	10/box	CP17	10/box
Female	3/8"	B	Steel	12-760	10/box	CP18-23	10/box
Female	1/2"	B	Steel	12-762	10/box	CP18	10/box
Hose Barb	1/2"	C	Steel	–	–	CP17-45	10/box
1/2" Body Series – Couplers							
Male	3/8"	D	Steel	–	–	C9-03	10/box
Male	1/2"	D	Steel	13-704	5/box	C9	10/box
Male	1/2"	D	Steel	–	–	C9-50	50/box
Male	1/2"	D	Steel	13-705	5/master*	–	–
Female	3/8"	E	Steel	–	–	C10-23	10/box
Female	1/2"	E	Steel	13-712	5/box	C10	10/box
Female	1/2"	E	Steel	–	–	C10-50	50/box
Female	1/2"	E	Steel	13-713	5/master*	–	–
Hose Barb	1/2"	F	Steel	–	–	C10-45	10/box
Hose Barb	1/2"	F	Steel	–	–	C10-45-50	50/box

*Carded display package

WARNING: Due to their large size, these couplers should not be connected or disconnected if the line pressure exceeds 40 PSI.

WARNING: Couplers and plugs are intended for use on compressed air lines only. All have maximum rated working pressure of 300 PSI.

I/M Style Design

(Two Narrow Bands on Coupler Body)

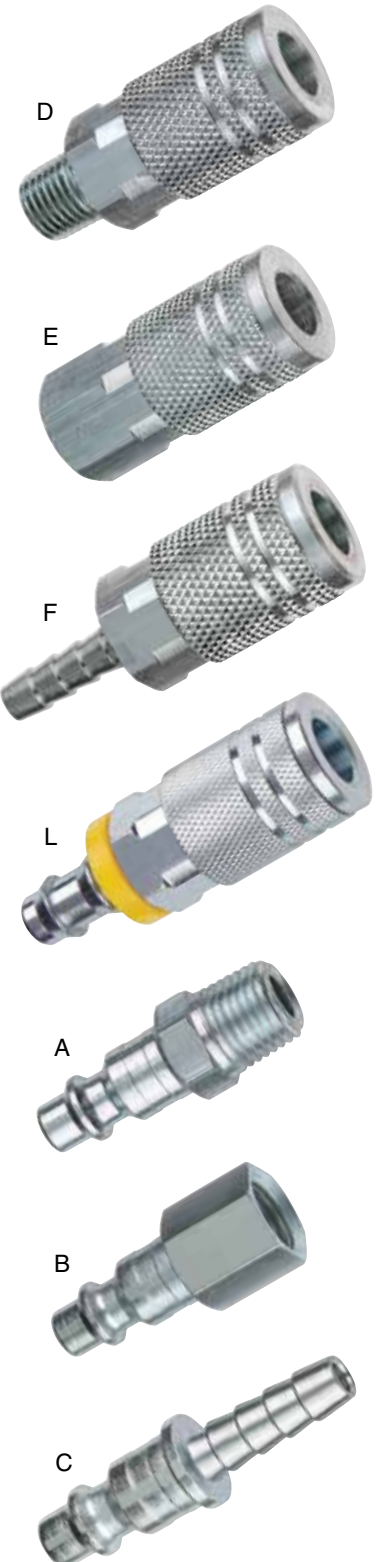

A-Style Design

(One Wide Band on Coupler Body)

This design is identified by a 5/16" pilot and ball groove which is nearly round. It is similar in appearance to the Industrial interchange and care must be taken to correctly identify it. Couplers are available in both standard and push-to-connect style sleeve.

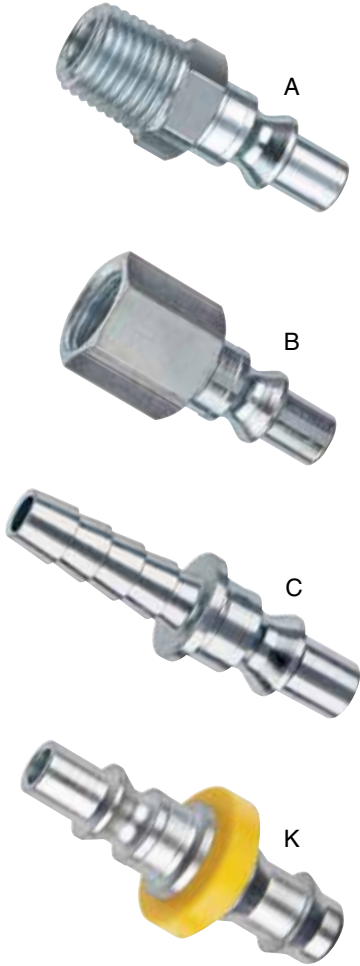

Thread	NPT	Style	Metal	Tru-Flate	Quantity	Amflo	Quantity
1/4" Body Series – Plugs							
Male	1/4"	A	Steel	12-324	10/box	CP37	10/box
Male	1/4"	A	Steel	12-324-07	250/box	CP37-100	100/box
Male	1/4"	A	Steel	–	–	CP37-500	500/box
Male	1/4"	A	Steel	12-325	10/master*	–	–
Male	1/4"	A	Brass	–	–	CP37B	10/box
Male	3/8"	A	Steel	–	–	CP37-03	10/box
Female	1/4"	B	Steel	12-334	10/box	CP38	10/box
Female	1/4"	B	Steel	–	–	CP38-100	100/box
Female	1/4"	B	Steel	12-335	10/master*	–	–
Female	1/4"	B	Brass	–	–	CP38B	10/box
Female	3/8"	B	Steel	–	–	CP38-23	10/box
Hose Barb	1/4"	C	Steel	–	–	CP37-42	10/box
Hose Barb	3/8"	C	Brass	–	–	CP37-44B	10/box
Lock-On	3/8"	K	Steel	–	–	CP37-44L	10/box

Plug/Coupler Sets				
One each of Tru-Flate 12-325 and 13-335	13-301	10/master*	–	–
One 13-774, three 12-324 and one 12-334	13-303	5/master*	–	–

*Carded display package

WARNING: Due to their large size, these couplers should not be connected or disconnected if the line pressure exceeds 40 PSI.

WARNING: Couplers and plugs are intended for use on compressed air lines only. All have maximum rated working pressure of 300 PSI.

Thread	NPT	Style	Metal	Tru-Flate	Quantity	Amflo	Quantity
1/4" Body Series – Couplers							
Male	1/4"	D	Steel	–	–	C37	10/box
Male	1/4"	D	Steel	–	–	C37-100	100/box
Male	1/4"	D	Brass	13-324	10/box	–	–
Male	1/4"	D	Brass	13-325	10/master*	–	–
Male	3/8"	D	Steel	–	–	C37-03	10/box
Female	1/4"	E	Steel	–	–	C38	10/box
Female	1/4"	E	Steel	–	–	C38-100	100/box
Female	1/4"	E	Brass	13-334	10/box	C38B	10/box
Female	1/4"	E	Brass	13-335	10/master*	–	–
Female	3/8"	E	Steel	–	–	C38-23	10/box
Hose Barb	1/4"	F	Steel	–	–	C38-42	10/box
Hose Barb	3/8"	F	Steel	–	–	C38-44	10/box
1/4" Push Couplers							
Male	1/4"	G	Steel	–	–	C45	10/box
Female	1/4"	H	Steel	13-774	10/box	C46	10/box
Female	1/4"	H	Steel	13-775	10/master*	–	–

3/8" Body Series – Plugs							
Male	3/8"	A	Steel	–	–	CP35	10/box
Female	3/8"	B	Steel	–	–	CP36	10/box
3/8" Body Series – Couplers							
Male	3/8"	D	Steel	–	–	C35	10/box
Female	3/8"	E	Steel	–	–	C36	10/box

*Carded display package

A-Style Design

(One Wide Band on Coupler Body)



D



E

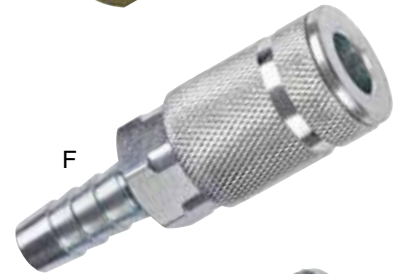

F



G



H

WARNING: Due to their large size, these couplers should not be connected or disconnected if the line pressure exceeds 40 PSI.

WARNING: Couplers and plugs are intended for use on compressed air lines only. All have maximum rated working pressure of 300 PSI.



Plugs & Couplers

L-Style Design

(One Wide and One Narrow Band on Coupler Body)

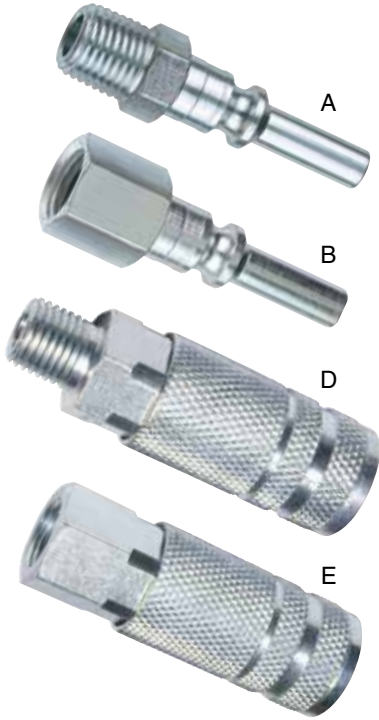

This plug is the most easily recognized design. The long 3/4" pilot is so distinctive it cannot be confused with any other designs. Couplers are available in sleeve type only.

Thread	NPT	Style	Metal	Tru-Flate	Quantity	Amflo	Quantity
1/4" Body Series – Plugs							
Male	1/4"	A	Steel	12-424	10/box	CP27	10/box
Male	1/4"	A	Steel	–	–	CP27-100	100/box
Male	1/4"	A	Steel	12-425	10/master*	–	–
Female	1/4"	B	Steel	12-434	10/box	CP28	10/box
Female	1/4"	B	Steel	–	–	CP28-100	100/box
Female	1/4"	B	Steel	12-435	10/master*	–	–
1/4" Body Series – Couplers							
Male	1/4"	D	Steel	13-424	10/box	C27	10/box
Male	1/4"	D	Steel	–	–	C27-25	25/box
Male	1/4"	D	Steel	13-425	10/master*	–	–
Female	1/4"	E	Steel	13-434	10/box	C28	10/box
Female	1/4"	E	Steel	–	–	C28-100	100/box
Female	1/4"	E	Steel	13-435	10/master*	–	–
Plug/Coupler Set							
One each of Tru-Flate 12-425 and 13-435				13-401	10/master*	–	–

HI-FLO® Design

(One Extra-Wide Band on Coupler Body)

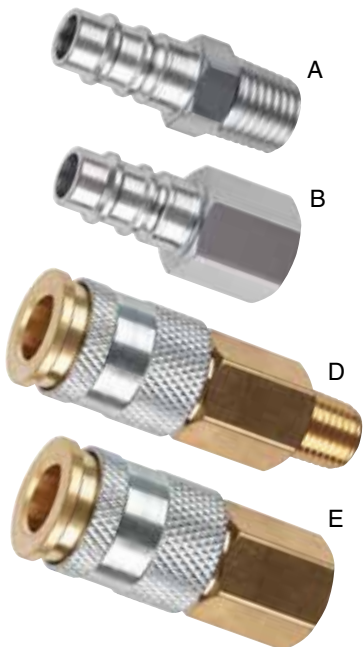

1/8" V-style HI-FLO couplers and plugs are specifically designed for use in HVLP (High Volume, Low Pressure) situations, such as paint spray guns, abrasive blast cabinets and high cfm air tools.

Thread	NPT	Style	Metal	Tru-Flate	Quantity	Amflo	Quantity
HI-FLO Series – Plugs							
Male	1/4"	A	Steel	–	–	CP91	10/box
Male	1/4"	A	Steel	–	–	CP91-100	100/box
Female	1/4"	B	Steel	–	–	CP90	10/box
Female	1/4"	B	Steel	–	–	CP90-100	100/box
HI-FLO Series – Push-To-Connect Couplers							
Male	1/4"	D	Brass	–	–	C91	10/box
Male	1/4"	D	Brass	–	–	C91-100	100/box
Female	1/4"	E	Steel	–	–	C98	10/box
Female	1/4"	E	Brass	–	–	C90	10/box
Female	1/4"	E	Brass	–	–	C90-100	100/box

*Carded display package

WARNING: Due to their large size, these couplers should not be connected or disconnected if the line pressure exceeds 40 PSI.

WARNING: Couplers and plugs are intended for use on compressed air lines only. All have maximum rated working pressure of 300 PSI.

Plugs & Couplers



These couplers and plugs have no valves. Smooth straight-thru bore allows maximum flow. Made from solid brass bar stock. Couplers have stainless steel springs and balls. Excellent for carpet cleaners, vacuum service and pressure washers. Interchanges with Parker ST type.

Thread	NPT	Style	Metal	Tru-Flate	Quantity	Amflo	Quantity
Straight-Thru Series – Plugs							
Male	1/4"	A	Brass	–	–	CPST3B	10/box
Male	3/8"	A	Steel	–	–	CPST5	10/box
Male	3/8"	A	Brass	–	–	CPST5B	10/box
Male	1/2"	A	Brass	–	–	CPST7B	10/box
Female	1/4"	B	Brass	–	–	CPST4B	10/box
Female	1/4"	C	Brass	–	–	CPST17B	10/box
Female	3/8"	B	Steel	–	–	CPST6	10/box
Female	3/8"	B	Brass	–	–	CPST6B	10/box
Female	1/2"	B	Brass	–	–	CPST8B	10/box
Straight-Thru Series – Couplers							
Female	1/4"	D	Brass	–	–	CST4B	10/box
Female	1/4"	E	Brass	–	–	CST17B	10/box
Female	3/8"	D	Brass	–	–	CST6B	10/box
Female	1/2"	D	Brass	–	–	CST8B	10/box

ST- Style Design

(One Extra-Wide Band on Compact Coupler Body)

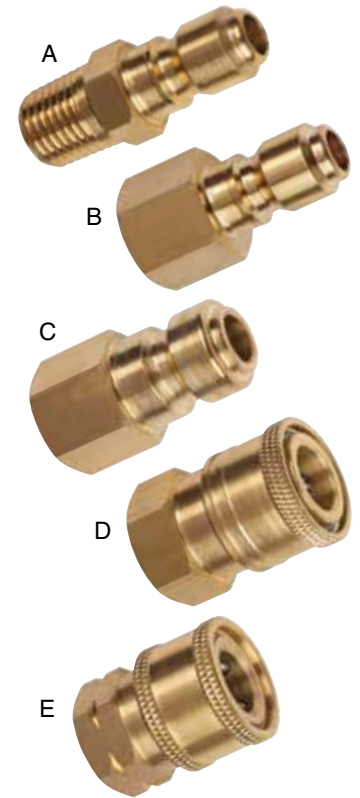

Diamond-U are primarily found on the West Coast. Plated steel couplers have hardened steel balls and stainless steel plugs. Plugs are heat treated to reduce wear on critical mating surfaces.

Thread	NPT	Style	Metal	Tru-Flate	Quantity	Amflo	Quantity
Diamond-U Series – Plugs							
Male	1/4"	A	Steel	–	–	CP33	10/box
Female	1/4"	B	Steel	–	–	CP34	10/box
Diamond-U Series – Couplers							
Male	1/4"	D	Steel	–	–	C31	10/box
Female	1/4"	E	Steel	–	–	C30	10/box
Female	1/4"	E	Steel	–	–	C30-100	100/box

D-Style Design

(Three Narrow Bands on Coupler Body)

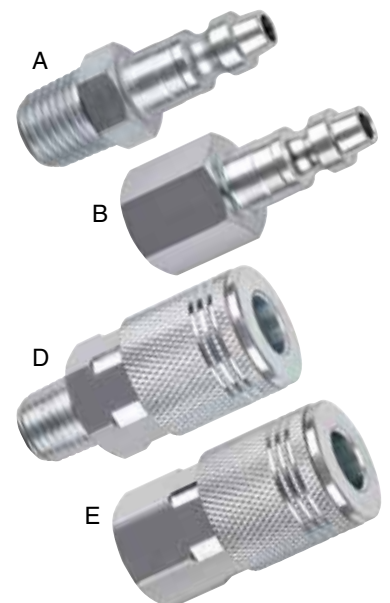

WARNING: Due to their large size, these couplers should not be connected or disconnected if the line pressure exceeds 40 PSI.

WARNING: Couplers and plugs are intended for use on compressed air lines only. All have maximum rated working pressure of 300 PSI.



Plugs & Couplers

Universal Design

Can be used with T, I/M and A Design 1/4" plugs, eliminating confusion among designs. Deluxe push-to-connect style makes coupling quick and easy. Heavy duty brass or composite construction means longer life. Unique tubular valve design allows greater air flow.

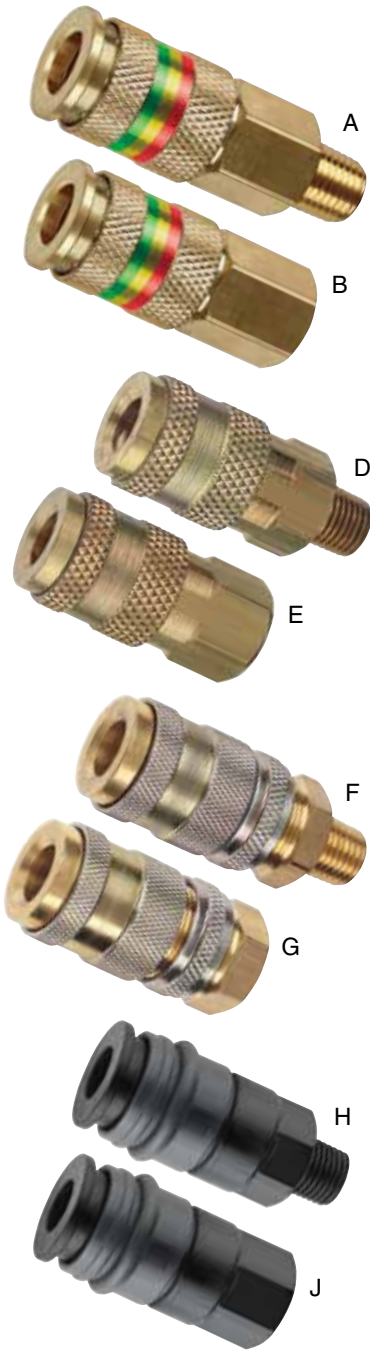

Thread	NPT	Style	Metal	Tru-Flate	Quantity	Amflo	Quantity
Combo Coupler® • 3 Year Leak-Proof Guarantee							
Male	1/4"	A	Brass	13-512	10/box	–	–
Male	1/4"	A	Brass	13-513	10/master*	–	–
Female	1/4"	B	Brass	13-514	10/box	–	–
Female	1/4"	B	Brass	13-515	10/master*	–	–
Universal Couplers							
Male	1/4"	D	Brass	13-508	10/box	C61	10/box
Male	1/4"	D	Brass	13-509	10/master*	–	–
Female	1/4"	E	Brass	13-510	10/box	C60	10/box
Female	1/4"	E	Brass	–	–	C60-100	100/box
Female	1/4"	E	Brass	13-511	10/master*	–	–
Locking Universal Couplers							
Male	1/4"	F	Brass	–	–	C87	10/box
Female	1/4"	G	Brass	–	–	C86	10/box
Composite Universal Couplers							
Male	1/4"	H	–	–	–	C61C	10/box
Male	1/4"	H	–	13-809	5/master*	–	–
Female	1/4"	J	–	–	–	C60C	10/box
Female	1/4"	J	–	13-811	5/master*	–	–

*Carded display package

WARNING: Due to their large size, these couplers should not be connected or disconnected if the line pressure exceeds 40 PSI.

WARNING: Couplers and plugs are intended for use on compressed air lines only. All have maximum rated working pressure of 300 PSI.

■ *Tru-Flate Part No.*

Tire Pressure Gauges

Standard Tire Gauge (10-50 lbs.)

Excellent for general-purpose use on passenger cars, vans and light trucks. Calibrated 2 sides, 10-50 PSI in 1 lb. units and 70-350 kPa in 10 kPa units.

17-509 Carded. 10/master.

Radial Tire Gauge (12-48 lbs.)

Designed specifically for radial tires on passenger cars, vans and light trucks. Calibrated 2 sides 12-48 PSI in 1 lb. units numbered every 4 lbs. and 2 sides 70-350 kPa in 10 kPa units.

17-515 Carded. 10/master.

Tractor Tire Gauge (5-45 lbs.)

For air and liquid filled tires. Includes special oiling and cleaning features to clean out corrosive fluids. For tractors, heavy equipment, farm and construction vehicles. Calibrated 5-45 PSI in 1 lb. units.

17-517 Carded. 10/master.

17-517-07 Bulk. 100/box.

Truck Tire Gauge (20-120 lbs.)

Ideal for all higher pressure applications on lightweight trucks (1/2 to 2-1/2 tons), step vans, pickups and air shocks. Calibrated 2 sides 20-120 PSI in 2 lb. units and 2 sides 160-880 kPa in 20 kPa units.

17-519 Carded. 10/master.

Low Pressure Tire Gauge (1-20 lbs.)

Low pressure readings at their best. Perfect for home garden tractors, golf carts, air springs and ATVs. Calibrated 1-20 PSI in 1/2 lb. units.

17-521 Carded. 10/master.

Easy Reach Tire Gauge (10-50 lbs.)

A must for tires with wheel covers. Straight-On type head makes hard-to-reach valves easy. Calibrated 10-50 PSI in 1 lb. units.

17-523 Carded. 10/master.

Bicycle Tire Gauge (20-120 lbs.)

Custom designed for high pressure tires on bicycles, motorcycles, mini-bikes, scooters and other cycles. Calibrated 2 sides 20-120 PSI in 2 lb. units and 2 sides 160-880 kPa in 20 kPa units.

17-527 Carded. 10/master.

Straight-On Truck Tire Gauge (20-120 lbs.)

Ideal for high pressure tires on large trucks with Budd wheels, step vans, pickups, air shocks and any difficult-to-reach high pressure reading. Perfect for inner wheels on duals, with large, easy-to-read numbers.

17-533 Carded. 10/master.

Economy Tire Gauges

Passenger Car Tire Gauge (10-50 lbs.)

Easy to use for passenger cars, vans and light trucks. Calibrated 2 sides 10-50 PSI in 1 lb. units and 2 sides 70-350 kPa in 10 kPa units.

17-529 Carded. 10/master.

Truck Tire Gauge (20-120 lbs.)

For accurate readings on high pressure tires for step vans, pickups, lightweight trucks (1/2 to 2 1/2 tons) and air shocks. Calibrated 2 sides 20-120 PSI in 2 lb. units and 2 sides 160-880 kPa in 20 kPa units.

17-531 Carded. 10/master.



Properly inflated tires can:

- Improve gas mileage up to 10%
- Improve tire life up to 30%
- Reduce chances of blowouts

WARNING: For best results, check pressure when tires are cold or when the vehicle has not been driven for several hours. Readings taken after driving can increase tire pressure, producing a false reading. Check tire pressure at least once a week or as necessary. Consult your Owner's Manual for the recommended air pressure for your tires. To avoid serious eye injury, eye protection must be worn when using these tools.

Tire Gauges



17-537



17-539

■ *Tru-Flate Part No.*

■ *Amflo Part No.*

Digital Tire Gauges

Digital Tire Gauge (5-99 lbs.)

Simply place the nozzle on the tire valve, wait a moment for the reading to lock into the display, remove the gauge and read the digital results. Gauge shuts off automatically upon removal.

17-537 Carded. 5/master.

Digital Tire Gauge (5-150 lbs.)

Easy to use and easy to read, even at night. Calibrated in 1/2 lb. units.

17-539 Carded. 6/master.

Dual Foot Gauges

Dual Foot Truck Gauge (20-120 lbs.)

For use on dual wheels and other difficult-to-reach valves. Fits in your pocket yet has enough range to handle both cars and trucks. Calibrated 20-120 PSI in 2 lb. units and from 150-820 kPa in 20 kPa units.

17-525 Carded. 10/master.

908-RET Carded. 10/master.

17-525-07 Bulk. 100/box.

Straight-On Dual Foot Truck Gauge (20-120 lbs.)

Tough black epoxy coated gauge. For use on dual wheels and other difficult-to-reach valves. Short enough to fit in your pocket yet has a wide enough range to handle both cars and trucks. Calibrated 20-120 PSI in 2 lb. units and from 140-820 kPa units.

17-542 1/box.

17-542-07 Bulk. 50/box.

Dual Foot Service Tire Gauge (10-150 lbs.)

For heavy-duty use required at the service level. Ideal for dual wheels and other difficult-to-reach valves on pickups, recreational vehicles, heavy trucks and off-road equipment. Chrome plated brass with a die-cast chuck. Calibrated 10-150 PSI in 2 lb. increments and from 100-1,040 kPa in 20 kPa increments. Includes handy hang-up hook.

17-545 Carded. 10/master.

902D Carded. 5/master.

Dual Foot Tire Gauge with Metal Bar (10-150 lbs.)

Same as above, but has unbreakable aluminum indicator bar.

903D Carded. 5/master.

Dual Foot Service Tire Gauge (10-150 PSI)

Same design and function as our standard dual foot service gauge with the addition of an 18 degree bend for more flexibility in accessing hard-to-reach tire valves.

17-556-07 Bulk. 100/Box.



17-525
908-RET



17-542



17-545
902D
903D



17-556-07

■ *Tru-Flate Part No.*

Straight-On Dual Foot Gauges

Digital Straight-On Dual Foot Service Tire Gauge (10-150 lbs.)

Same design and function as our standard Straight-On service gauge, but with the convenience of an easy-to-read, back-lit digital display. Reads in PSI, Bar, kPa and kgf/cm². Swivel head design enables tire valves to be reached from all directions.

17-547 Carded. 5/master.

Straight-On Dual Foot Service Tire Gauge (10-150 lbs.)

Tough black epoxy coated gauge. Designed for the difficult-to-reach inner dual. Straight-On chuck for inside wheel and 30 degree reverse angle for outside wheel. Calibrated 10-150 PSI in 2 lb. units and 100-1040 kPa in 20 kPa units.

17-548 1/box.

17-548-07 Bulk. 100/box.

Straight-On Dual Foot Service Tire Gauge (10-150 lbs.)

Designed for the difficult-to-reach inner dual. Straight-On chuck for inside wheel and 30° reverse angle for outside wheel.

17-565 Carded. 5/master.

Dial Gauges

Dial Tire Gauge (10-60 lbs.)

Professional type dial with steel casing and nickel plated brass chuck. Automatic reset. Pressure release valve. For cars, vans and light trucks.

17-551 Carded. 10/master.

Economy Dial Tire Gauge (1-50 lbs.)

Low cost dial gauge calibrated in both PSI and kPa in 1 lb. increments.

17-553 Carded. 10/master.

Dial Truck Tire Gauge (10-160 lbs.)

Easy-to-read dial gauge complete with a rugged protective rubber casing. Pressure holding gauge has an automatic reset/release valve. Includes a 12" flexible hose and chrome-plated zinc dual foot chuck.

17-555 Carded. 5/master.

Tire Gauge Displays

These eye-catching displays include Tru-Flate's standard or truck tire gauges in 5 vibrant metallic colors – red, blue, black, chrome and green. Designed to accommodate peg hook or countertop display, wherever your store traffic is heaviest.

Calibrated 2 sides 10-50 PSI in 1 lb. units and 70-350 kPa in 10 kPa units.

96-520 10-piece Tire Gauge display (17-509).

96-525 20-piece Tire Gauge display (17-509).

Calibrated 2 sides 20-120 PSI in 2 lb. units and 160-880 kPa in 20 kPa units.

96-540 10-piece Truck Tire Gauge display (17-519).



96-525

WARNING: To avoid serious eye injury, eye protection must be worn when using these tools.

Inflator Gauges

■ *Tru-Flate Part No.*

■ *Amflo Part No.*

Deluxe Inflator Gauges

Rugged zinc casting, with rubber bumper guard to protect against damage if dropped, and easy-to-read recessed sight glass. Replaceable valve assembly and gauging cartridge. Calibrated 10-120 PSI in 2 lb. steps.

With 12" Hose and Dual Foot Chuck.

17-850 Carded. 10/master. **180** Carded. 1/master.

17-850-07 Bulk. 30/box.

With 12" Hose and Straight-On Chuck.

17-851 Carded. 10/master.

With 24" Hose and "Grip-Tite" Chuck.

17-853 1/box.

With 24" Hose and Clip-On Chuck.

17-855 1/box.

With 12" Hose and Single Foot Chuck.

17-856 1/box.

With 12" Hose and Truck Gauge with 18° Bend Chuck.

17-866 10/box.

Deluxe Straight-On Inflator Gauges *with Bleeder Valve*

Same high quality inflator gauge but with a convenient bleeder valve to enable the operator to "zero" the gauge and release pressure during filling. Allows the operator to stand away from the tire being inflated and thus meets OSHA regulation No. 1910.177.

With 36" Hose and Straight-On Dual Foot Chuck.

17-860 1/box.

With 72" Hose and Locking Straight-On Dual Foot Chuck.

17-870 Has deep threaded well to lock onto valve when tilted. 1/box.

NOTE: Because of the internal construction of the Straight-On Dual Foot Chucks, they can only be installed on Tru-Flate® inflator gauges with bleeder valves.

Bayonet Style Inflator Gauges

Features rubber hose and chrome plated castings with brass internal parts for long life. Solid brass bar is calibrated 10-90 PSI in 2 PSI increments.

With 12" Hose and Straight-On Tapered Chuck.

17-865 Carded. 5/master. **150E-RET** Carded. 5/master.

17-862 1/box. **150** 1/box.

150-50 Bulk. 50/box.

With 12" Hose and Swivel Dual Foot Chuck.

17-863 1/box. **151** 1/box.

With 5' Hose, Bleeder Valve and European Style Chuck.

156 1/box.

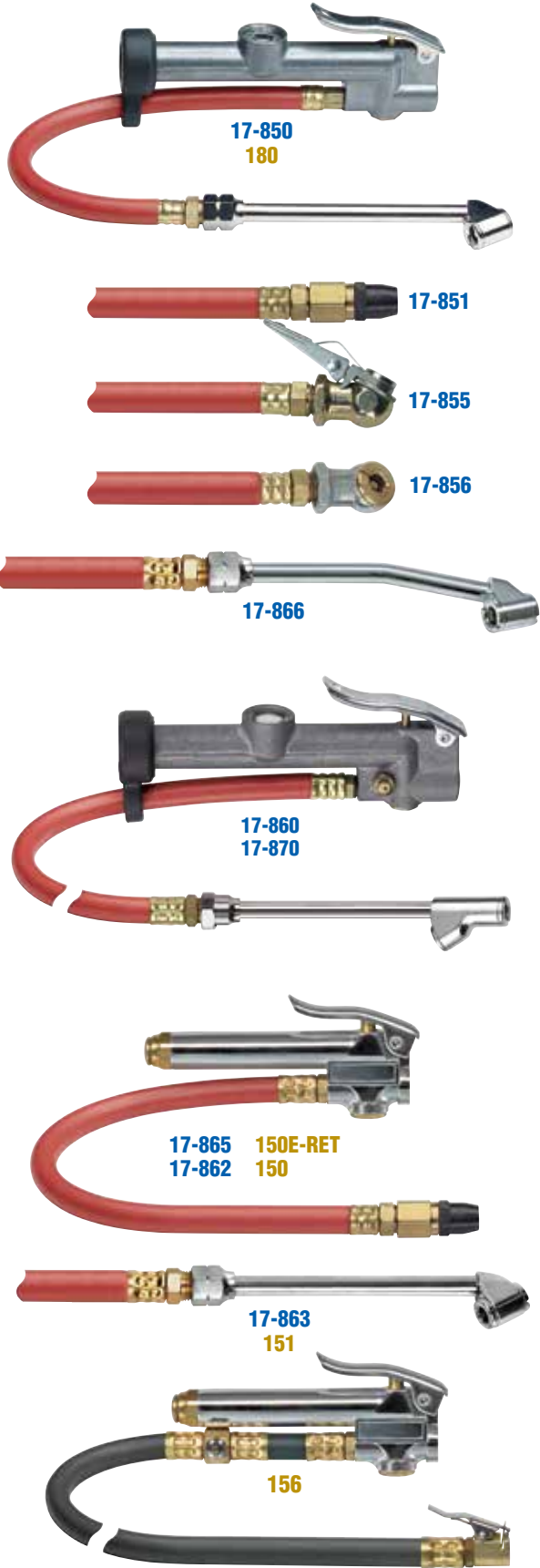

Inflator Gauges

■ *Tru-Flate Part No.*

■ *Amflo Part No.*

Heavy Duty Inflator Gauges

Heavy chrome plated castings with protective sleeve over dial tube. Plated steel handle is riveted to body. Solid brass bar is calibrated 10 to 120 PSI in 2 PSI increments.

Highly Accurate Dial Inflator. Easy-to-read dial is calibrated 0 to 160 PSI. Tapered chuck and swivel dual foot make getting into tight spots easy. A must for racing tires and truck fleets. **135** 1/box.

Straight-On Tapered Chuck Inflator. With 12" hose.
100D Carded. 1/master.
100 1/box.

Swivel Dual Foot Chuck Inflator. With 12" hose. For use on vehicles with smaller dual wheels.

101D Carded. 1/master.
101 1/box.
101-50 Bulk. 50/box.

Straight-On Dual Foot Chuck Inflator. Durable black epoxy finish.

101HD 1/box.



Master Air Inflator Gauges

Inflates and checks pressure of passenger cars, motorcycles and trucks. Has a five ft. hose length. Dual calibrated 10 to 170 PSI and .7 to 12 bar. Calibrated in 2 lb. increments.

3910S Master Air Inflator Gauge with standard bore. 1/box.
3912 Master Air Inflator Gauge with 1/4" MNPT fitting. 1/box.
3908 Thread adapter for 3910S (not shown). 1/4" FNPT. 1/box.



Inflator Gauge Components

12" Hose with Straight-On Chuck – No Adapters

17-708 1/box. **112** 1/box.

12" Hose with Dual Foot Chuck and Adapters. Converts 3/8-24 thread hose to 1/4-18 NPT and 1/8-27 NPT.

17-712 1/box. **113** 1/box.

Universal 12" Hose with Two Adapters – No Chuck

Converts 3/8-24 thread hose to 1/4-18 NPT and 1/8-27 NPT.

17-720 1/box. **110** 1/box.

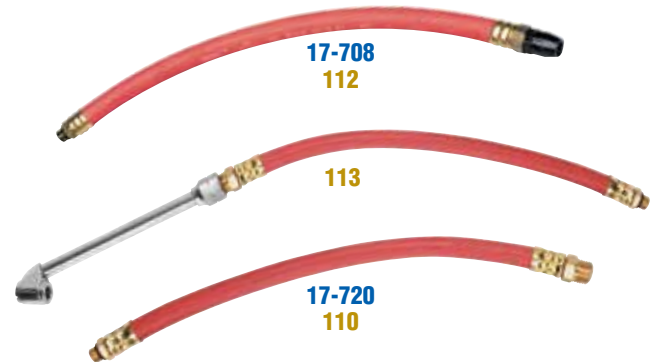

Other Components (not all shown)

17-707-07 Deluxe Inflator Gauge Body. Bulk. 30/box.
150LW-50 Bayonet Style Inflator Gauge Body. Bulk. 50/box.
100LW Heavy Duty Inflator Gauge Body. 1/box.
135DG Replacement Dial Gauge. For Amflo 135. 1/box.
153 Dial Bar for Bayonet Inflator Gauge. 1/bag.
163 Replacement Inflator Gauge Valve. For Amflo 150 series. 1/box.
17-893 Inflator Gauge Valve Assembly. 1/bag.
97-331 Replacement Sight Glass. 5/bag.
97-329 Standard Gauging Cartridge. Calibrated 10-120 PSI. 1/bag.
100-16 Replacement Chuck Nut. For Amflo 100 Inflator Gauge. 10/box.

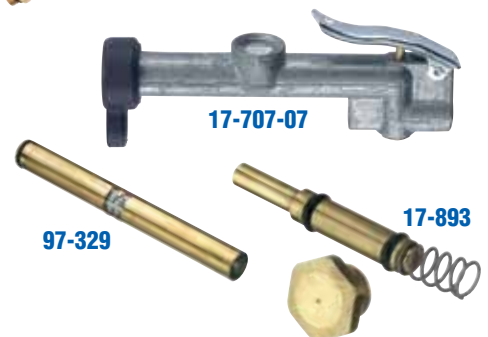

Air Line Chucks

■ *Tru-Flate Part No.*

■ *Amflo Part No.*

Air Line Chucks without Shut-Off *for Inflator Gauges only*

Do not use on direct air lines where a shut-off valve is required.

Snap-On Chuck Clip. Converts any single foot chuck to a clip-on chuck.

17-355 Carded. 10/master.

Mini Lock-On Air Chuck. Newer “mini-style” is standard equipment on rim clamp (RC) tire changers.

17-365 Carded. 10/master.

Single Ball Foot Chuck. 1/4" FNPT.

17-722 10/box.

104G 10/box.

104G-100 Bulk. 100/box.

Dual Foot Chuck. 1/4" FNPT.

17-724 10/box.

107 1/box.

“Grip Tite” Chuck. 1/4" FNPT. Straight-on air line chuck.

Snaps onto standard tire valve and stays put until disconnected.

17-726 1/bag.

120 10/box.

Straight-On Chuck. 1/4" FNPT, with universal adapter.

17-729 Carded. 10/master.

127 10/box.

Straight-On Chuck with 1/4" Hose Barb. 1/4" FNPT.

106-100 Bulk. 100/box.

Clip-On Chuck. 1/4" FNPT, with universal adapter.

17-730 10/box.

104GCA 10/box.

Straight Lock-On Chuck. 1/4" FNPT. Flow-through.

17-732 10/box.

17-732-07 Bulk. 100/box.

Angled Chuck. 1/4" FNPT.

105 10/box.

Air Line Chucks with Shut-Off *not for Inflator Gauge use*

Direct Air Line Chucks have a built-in shut-off valve and therefore cannot be used on inflator gauges. Use when air supply lines come directly from the compressor with no other valve in the line. 1/4" female NPT. 150 PSI maximum air line pressure.

Ball Foot Chucks (for direct air lines only)

17-351 Carded. 10/master.

104D Carded. 10/master.

17-350 10/box.

104 10/box.

104-100 Bulk. 100/box.

Zinc Coated Ball Foot Chucks

104ZND-RET

Carded. 10/master.

Ball Foot Chuck With Snap on Clip Combination Tru-Flate 17-350 with 17-355

17-353 Carded. 10/master.

104CA 10/box.



Air Line Chucks

■ *Tru-Flate Part No.*

■ *Amflo Part No.*

Air Line Chucks with Shut-Off *not for Inflator Gauge use*

17-361 **Combination 17-350 with 1/4" ID Hose Barb.** Carded. 10/master.

17-362 **Straight Lock-On Chuck.** 10/box.

17-369 **Ball Foot Chuck.** 1/4" MNPT. Carded. 10/box.

Snap-On Chuck Clip. Converts any single foot chuck to a clip-on chuck.

17-355 Carded. 10/master.

"Grip Tite" Chuck. Works like a "quick coupler." Snaps onto any standard tire valve and stays put until released.

17-373 Carded. 10/master. **119** 10/box.

Straight-On Chuck. Smaller design for use on those hard-to-reach tire valves.

17-375 Carded. 10/master. **126** 10/box.

Dual Foot Chuck. Dual foot extension for valves on tractors, trucks or buses.

17-383 Carded. 10/master.

17-382 10/box.

Straight-On Dual Foot Chuck. For hard-to-reach inner duals.

17-385 Carded. 10/master. **108-RET** Carded. 10/master.

17-384 10/box. **108** 1/box.

121 12" length. 1/box.

Deluxe Straight-On Dual Foot Chuck. With durable black powder coating.

17-386 1/box.

17-386-07 Bulk. 50/box.

Dual Foot Safety Lock-On Chuck. **118D** Carded. 1/master.

Locking Straight-On Dual Foot Chuck

Comes with threaded deep well lock nut which locks on valve when tilted.

17-395 Carded. 10/master.

17-396 10/box.

17-398 12" length (14" overall). 5/box.

Large Bore Clip-On Air Chuck. Snaps on the large bore valve when sleeve is moved forward and releases when sleeve is pulled back. 1/4" NPT.

17-392 1/bag.

Large Bore Chuck. Grips bore valve when tilted on threads.

17-394 1/box.

Air Line Chuck Service Parts *(not shown)*

97-350 **Repair Kit.** For Single Ball Foot Chucks. 1/bag.

97-351 **Washer only.** For Single Ball Foot Chucks. 10/bag.

97-353 **Washer only.** For Dual Foot Chucks. 10/bag.

97-354 **Repair Kit.** For Dual Foot Chucks. 1/bag.

859W **Chuck Washer.** For Straight-On and Dual Foot Chucks. 10/box.

859W-500 **Chuck Washer.** For Straight-On and Dual Foot Chucks. Bulk. 500/box.



17-361



17-362



17-369



17-355



17-373
119



17-375
126



17-382
17-383

17-384
17-385
17-395
17-396
108



17-386

121
17-398



118D

17-392

17-394

Blowguns

■ *Tru-Flate Part No.*

■ *Amflo Part No.*

Standard Blowguns

All have 1/4" female NPT inlet – allows full line pressure to be used.

IMPORTANT: To comply with OSHA regulations, Standard Blowguns must be used on a regulated air line with a pressure setting not to exceed 30 PSI.

Standard Blowgun

Comfortable thumb lever valve control with hang hook. One-piece nozzle.

18-203 Carded. 5/master. **200-RET** Carded. 5/master.

18-202 1/box. **200** 1/box.

200-100 Bulk. 100/box.

Same as above, without nozzle **200LT-100** Bulk. 100/box.

Standard Blowgun with Rubber Tip

Oil resistant, soft replaceable rubber tip. Will not mar delicate surfaces.

Gives a leakproof seal against oil passages, fuel lines, etc., when air pressure is needed for cleaning.

18-207 Carded. 5/master. **201-RET** Carded. 5/master.

201 1/box.

201-100 Bulk. 100/box.

Flex-Tipped Blowgun

No handles, levers or buttons. Simply flex rubber nozzle to open.

Release, and air shuts off automatically.

18-212 10/box. **211** 10/box.

211-100 Bulk. 100/box.

Siphon Spray Blowgun

Combination of a Standard Blowgun and the Siphon Spray Nozzle.

Barbed siphon inlet fits 1/4" ID hose or tubing. Use for spray-cleaning engines, applying protective coatings, etc.

18-221 Carded. 5/master.

With 8' hose included

18-223 Carded. 5/master. **220TD** Carded. 1/master.

220T 1/Box.

Pistol-Grip Spray Cleaner

Air-operated siphon cleaning gun handles most cleaning fluids. Ideal for mixing water or soap solutions for pressure cleaning of parts, engines, machinery, floors and walls. Dual air inlet allows handy overhead or under-bench connection. Includes 8' of clear vinyl tubing with a weighted strainer screen and fluid control valve. 10" spray nozzle.

18-225 Carded. 5/master.

Deluxe Blowgun Kit

All purpose blowgun kit with 4 interchangeable nozzles for cleaning and inflating. Perfect for blowing sawdust and grass clippings, drying surfaces or inflating balls, rafts and air mattresses. Complete with Standard Nozzle, Rubber Tip Nozzle, Tapered Inflator Nozzle and Ball Inflator Needle – all in a convenient see-through plastic storage case.

18-241 5/master.

200K-RET 5/master.

Palm Style Blowgun Kit

Lightweight, ergonomic design blowgun fits comfortably in the palm of your hand. Kit includes 6 interchangeable nozzles, 1/4" air plug and a 12" hose and air chuck assembly.

18-247 5/master.

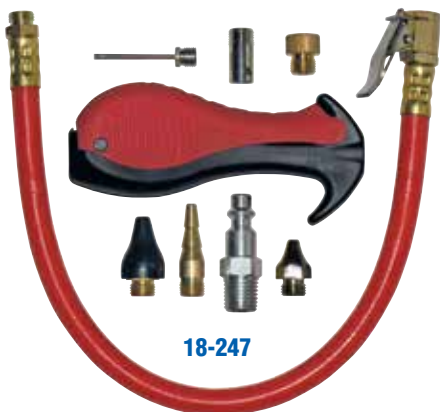
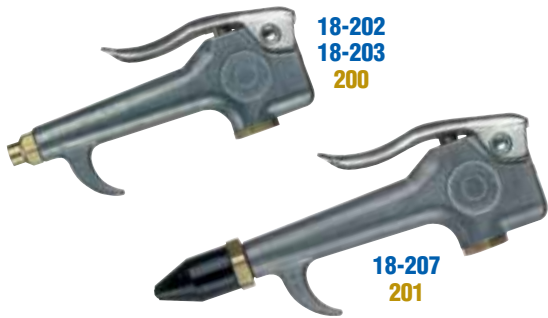

■ *Tru-Flate Part No.*

■ *Amflo Part No.*

Standard Blowguns (cont.)

Pistol-Grip Blowgun

Lightweight plastic pistol-grip blowgun with ergonomic design reduces user fatigue. Brass valving and bushing ensure long life.

18-325 Carded. 5/master. **204-30STD** Carded. 5/master.
204-30ST 1/box.

Heavy Duty Angle Tip Blowgun

Heavy duty construction and rubber tip. Excellent for blowing out automatic transmissions.

205ATD Carded. 5/master.
205AT 1/box.

Heavy Duty Blowgun

Use in construction and other rugged applications. Standard 1/8" NPT nozzle thread.

205D Carded. 5/master.
205 1/box.

Booster Blowgun

Delivers extra wide spray pattern. Additional air is drawn through holes around nozzle.

226 1/box.

Safety Blowguns

Improved nozzle gives greatly increased performance and yet still meets OSHA regulation 100-1 for 30 PSI "dead head" pressure. Vented nozzle relieves compressed air should nozzle become plugged or obstructed. Heavy duty die-cast body with hang-up hook and 1/4" NPT female inlet.

Button Type. Inlet pressure 150 PSI.

18-231 Carded. 5/master.

Lever Type. Inlet pressure 150 PSI.

18-233 Carded. 5/master. **204-30** 1/box.

18-232 1/box.

Tamper Proof Lever Type. Safety nozzle cannot be removed from end.

18-237 Carded. 5/master. **204-30A-RET** Carded. 5/master.

204-30A 1/box.

204-30A-100 Bulk. 100/box.

Pocket Size Lever Type. Inlet pressure 150 PSI.

18-319 Carded. 5/master.

Pocket Size with 4" Vented Extension. Inlet pressure 150 PSI.

18-302 Carded. 10/master.

Clip-On Safety Blowgun. Chuck style, 8-1/2". Converts standard ball foot air chuck into a blowgun.

18-143 10/box.

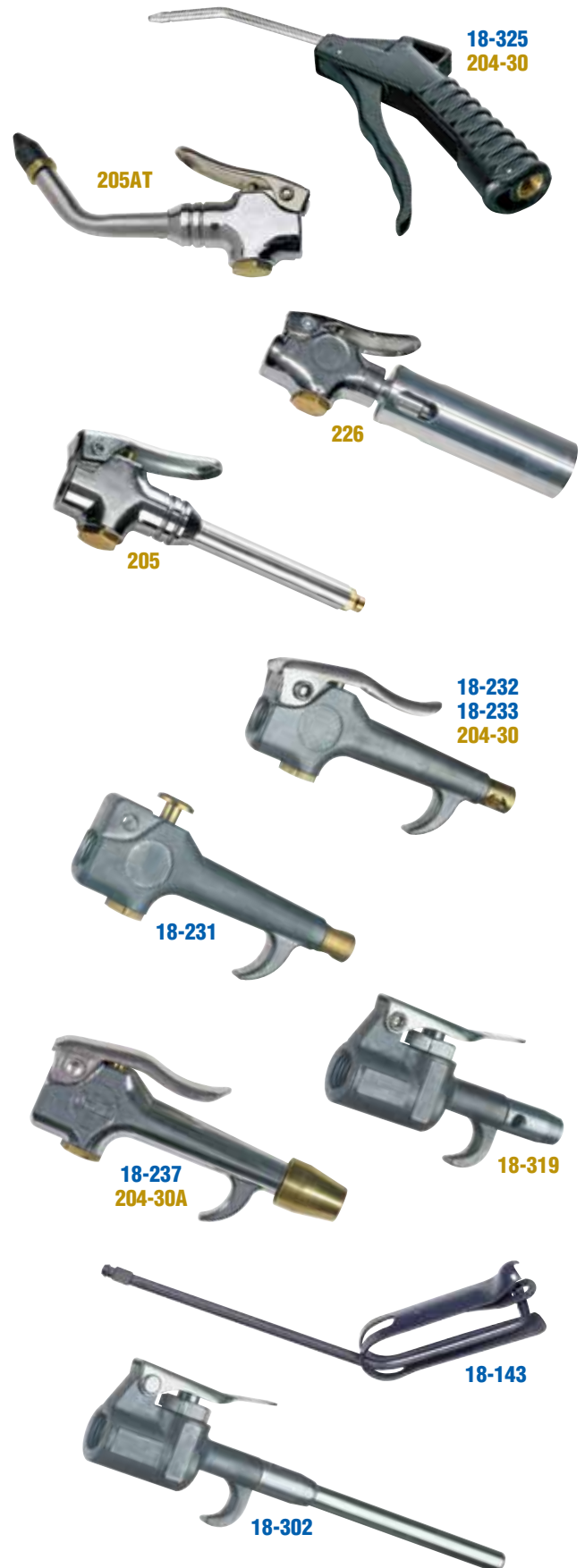

Blowguns

■ *Tru-Flate Part No.*

■ *Amflo Part No.*

Safety Blowguns (cont.)

High Volume "Venturi" Action

Delivers more air-to-speed cleaning and drying while using less compressed air. Special venturi nozzle increases air flow to part, yet meets OSHA regulation 100-1. Convenient hang-up hook, comfortable lever and 1/4" NPT female inlet. 150 PSI inlet pressure.

18-208 1/box.

208D Carded. 5/master.

208 1/box.

Safety Blowgun with Rubber Tip & Safety Nozzle

Oil resistant, soft rubber tip seals tight and won't mar finishes. Ideal for cleaning fuel lines, air passages and carburetors. Limits air pressure to 30 PSI, meeting OSHA safety standards. Convenient hang-up hook. 1/4" NPT female inlet. 150 PSI inlet pressure.

18-215 Carded. 5/master.

Safety Extension Blowgun with Rubber Tip & Safety Nozzle

These multi-function, long reach blowguns come with both a safety nozzle and rubber tip. End of blowgun is bent for hard-to-reach areas.

18-217 With 2' extension. 1/bag, 5/master.

18-219 With 4' extension. 1/bag, 5/master.

Adjustable Safety Pocket Blowguns

A must for home, shop or garage use. Quick and easy to use – just attach to air line coupler and twist knurled nozzle. For 1/4" coupler bodies. Meets OSHA regulation 100-1. Complete with handy pocket clip.

T-Style Design

18-601 Carded. 10/master. **217D** Carded. 10/master.

I/M Style Design

18-603 Carded. 10/master. **219** 10/box.

219-100 Bulk. 100/box.

A-Style Design

18-605 Carded. 10/master.

Strata-Flo Blowgun

Special design concentrates air into a powerful stream. No through-hole design prevents dangerous pressure buildup and reduces air turbulence, making it much quieter than most blowguns.

212 1/box.

Safety Blowgun with Extension

Same features as our other safety blowguns with the added convenience of longer extensions for hard-to-reach areas.

204-30-6 With 6" extension. 1/box.

204-30-12 With 12" extension. 1/box.

HI FLO® Blowgun

This powerful blowgun is built for demanding professionals, delivering over twice the delivery of a standard blow gun. Features a 1/4" MNPT inlet, cushioned handle and finger-grip trigger. Optional tips are also available.

228 Carded. 5/master.

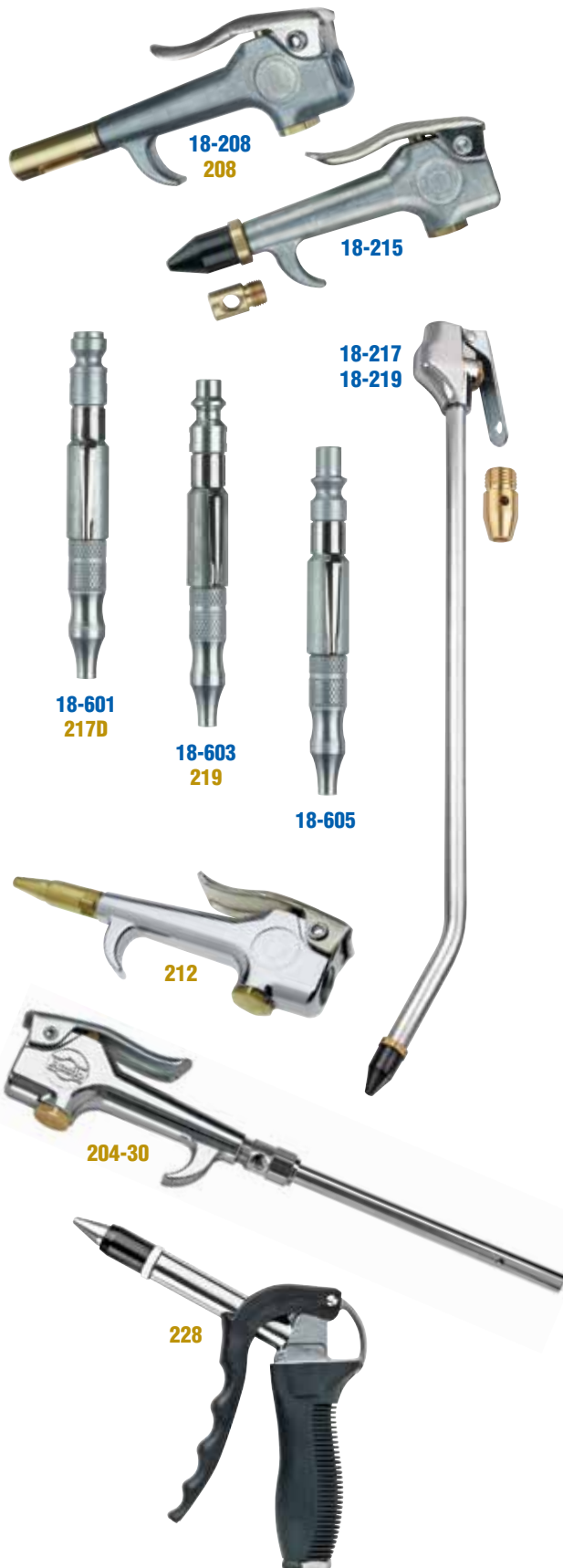

■ *Tru-Flate Part No.*

■ *Amflo Part No.*

Blowgun Accessories

Blowgun tips and extensions on this page have 1/8" NPT male threads.

Standard Chrome Plated Extension. 1/4" tubing. 6" length.

200E6 1/bag.

Blowgun Tip Assortment. Stainless steel tubes with chrome plated brass fittings, in 5 sizes.

200NTD Carded. 1/master.

Replacement Needles. All 1/8" NPT. Bulk. 10/box.

200NT-1 2-3/4" length.

200NT-2 2-1/2" length.

200NT-3 1-3/4" length.

200NT-4 1-1/8" length.

200NT-5 1/8" length.

Flexible Metal Extension. Use for air or coolant lines. 8" length.

200F8 1/bag.

Safety Extensions. With safety bypass – cannot be dead-ended.

204E6 6" length. 1/bag.

204E12 12" length. 1/bag.

204E24 24" length. 1/bag.

204E36 36" length. 1/bag.

HI FLO® Triple Venturi Tip. For Amflo 228 blowgun.

228-VT Carded. 5/master.

Standard Replacement Tip. For Tru-Flate 18-202 and 18-203; Amflo 200 and 205 blowguns.

200T 10/box.

Safety Nozzle. For Tru-Flate 18-231, 18-232 and 18-233; Amflo 204-30.

97-412 20/box.

Rubber Replacement Tip. For Tru-Flate 18-207 and Amflo 201 blowguns.

99-005 Carded. 10/master. **202** 10/master.

Venturi Tip. For Tru-Flate 18-208 and Amflo 208 blowguns.

209 10/box.

Strata-Flo Replacement Tip. For Amflo 212 blowgun.

213 1/bag.

Siphon Spray Nozzle. For Tru-Flate 18-221 and 18-223 blowguns.

221 10/box.

Booster Replacement Tip. For Amflo 226 and 228 blowguns.

227 1/box.

228-BT Carded. 5/master.

Heavy Duty Blowgun Repair Kit. Everything you need for quick, easy repairs. Contains valve stem, O-rings, spring and nut.

40-205RK 1/bag.



Hose Fittings

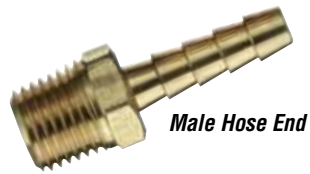

Male Hose End



Male Ball Swivel Fitting



Male Swivel Fitting

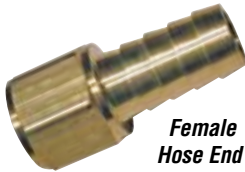

Female Hose End

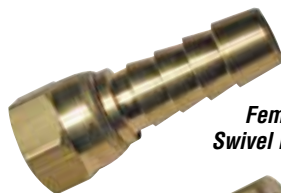

Female Swivel Fittings

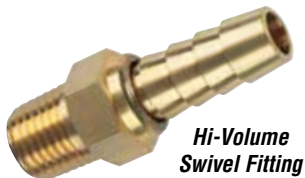

Hi-Volume Swivel Fitting

■ Tru-Flate Part No.

■ Amflo Part No.

Barbed Hose Fittings

All brass construction resists rust and will not corrode as easily as other materials. Precision machined to high quality standards. Use with hose clamp or ferrules.

Male Hose End

	399	1/8" Hose ID x 1/8" MNPT. 10/box.
	404	1/4" Hose ID x 1/8" MNPT. 10/box.
	401	1/4" Hose ID x 1/4" MNPT. 10/box.
	401-100	1/4" Hose ID x 1/4" MNPT. 100/box.
21-123		1/4" Hose ID x 1/4" MNPT. Carded. 10/master.
	604	1/4" Hose ID x 3/8" MNPT. 10/box.
	398	1/4" Hose ID x 3/8"-24. With O-ring. 10/box.
	398-100	1/4" Hose ID x 3/8"-24. With O-ring. Bulk. 100/box.
21-133		5/16" Hose ID x 1/4" MNPT. Carded. 10/master.
	405	5/16" Hose ID x 1/4" MNPT. 10/box.
21-143		3/8" Hose ID x 1/4" MNPT. Carded. 10/master.
	406	3/8" Hose ID x 1/4" MNPT. 10/box.
	406-100	3/8" Hose ID x 1/4" MNPT. Bulk. 100/box.
21-147		3/8" Hose ID x 3/8" MNPT. Carded. 10/master.
	606	3/8" Hose ID x 3/8" MNPT. 10/box.
	408	1/2" Hose ID x 1/4" MNPT. 10/box.
	608	1/2" Hose ID x 3/8" MNPT. 10/box.
	808	1/2" Hose ID x 1/2" MNPT. 10/box.
	814	3/4" Hose ID x 3/4" MNPT. 10/box.
	444S	Ball swivel fitting. 1/4" Hose ID x 1/4" MNPT. 10/box.
	446S	Ball swivel fitting. 3/8" Hose ID x 1/4" MNPT. 10/box.

Swivel fitting. 1/4" Hose ID x 1/4" MNPT.

401S	10/box.
401S-100	Bulk. 100/box.

Female Hose End 1/4" Hose ID x 1/4" FNPT.

21-222	10/box.	441	10/box.
---------------	---------	------------	---------

3/8" Hose ID x 1/4" FNPT.

21-242	10/box.	461	10/box.
---------------	---------	------------	---------

3/8" Hose ID x 3/8" FNPT.

21-262	10/box.
21-323	Swivel fitting. 1/4" Hose ID x 1/4" FNPS. Carded. 10/master.
463	Swivel fitting. One-piece. 3/8" Hose ID x 1/4" FNPT. 10/box.
442	Swivel fitting. Two-piece. 1/4" Hose ID x 1/4" FNPT. 10/box.

Hi-Volume Swivel Fittings

406S	3/8" Hose ID x 1/4" MNPT. 10/box.
-------------	-----------------------------------

■ *Tru-Flate Part No.*

■ *Amflo Part No.*

Lock-On Hose Barbs

Designed to use with lock-on hose. No ferrules or hose clamps are required. Not to be used with conventional hose.

406L	3/8" Hose ID x 1/4" MNPT. 10/box.
406LD-RET	3/8" Hose ID x 1/4" MNPT. Carded. 10/master.
446SL	Swivel fitting. 3/8" Hose ID x 1/4" MNPT. 10/box.



*Lock-On
Hose Barb*

Hose Splicers

21-422	1/4" Hose ID. 10/box.
21-423	1/4" Hose ID. Carded. 10/master
402	1/4" Hose ID. 10/box.
21-432	5/16" Hose ID. 10/box.
21-433	5/16" Hose ID. Carded. 10/master.
21-466	3/8" Hose ID. 10/box.
602	3/8" Hose ID. 10/box.
602-50	3/8" Hose ID. Bulk. 50/box.
21-467	3/8" Hose ID. Carded. 10/master.
21-488	1/2" Hose ID. 10/box.
802	1/2" Hose ID. 10/box



*Lock-On
Swivel Fitting*



Hose Splicer

360° Swivel Fittings

Eliminates kinked and twisted air line hose by swiveling a full 360°. Barb type and male/female connections. 150 PSI maximum working pressure.

21-601	1/4" MNPT x 1/4" Hose Barb. Carded. 10/master.
21-603	1/4" MNPT x 3/8" Hose Barb. Carded. 10/master.
21-605	1/4" MNPT x 1/4" FNPT. Carded. 10/master.

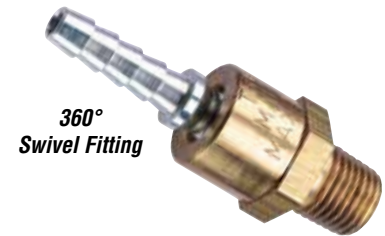

*360°
Swivel Fitting*

Hose Clamps

Gear type clamps permit quick hose repair with simple tools. Rugged construction featuring a stainless steel band and plated steel screw.

1/4" to 5/8" Hose OD, 5/16" clamp width.	
580-100	100/box.
3/8" to 7/8" Hose OD, 5/16" clamp width.	
581-100	Bulk. 100/box.
582	1/2" to 1-1/4" Hose OD, 5/16" clamp width. 10/box.

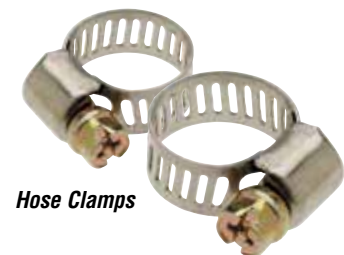

Hose Clamps

Hose Fittings

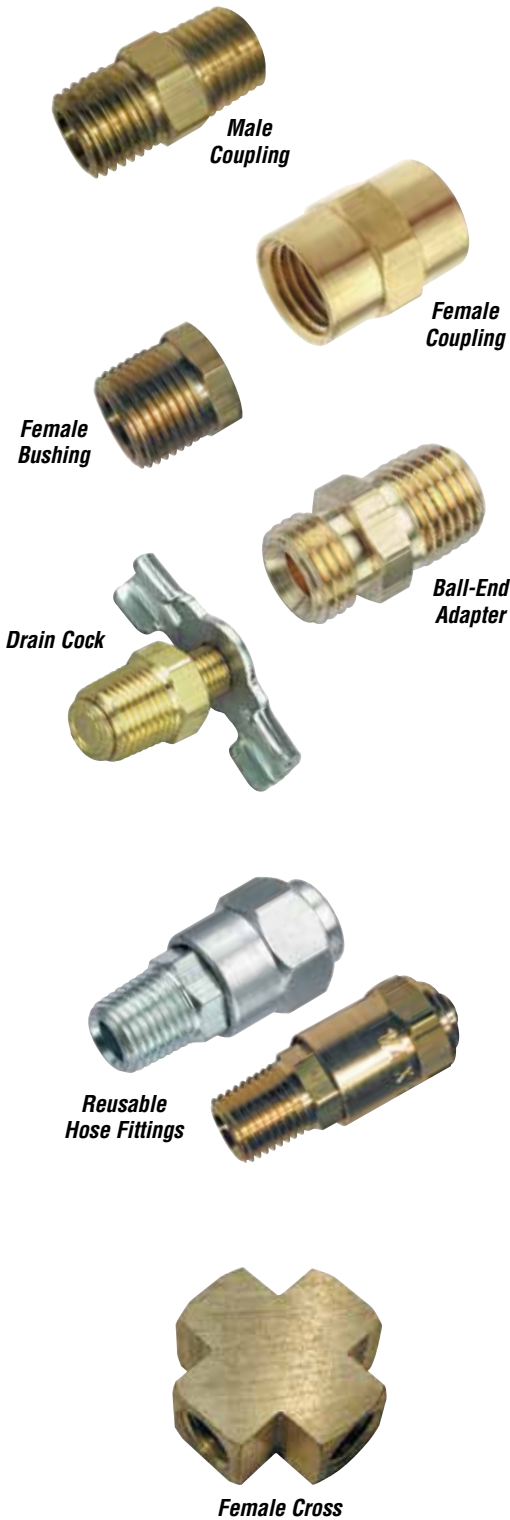

■ *Tru-Flate Part No.*

■ *Amflo Part No.*

Pipe Couplings and Adapters

All brass, corrosion resistant material. Allows user to adjust thread sizes from 1/8" NPT through 1/2" NPT with either male or female ends.

Male Couplings

21-505	1/4" MNPT x 1/4" MNPT. Carded. 5/master.	344	1/4" MNPT x 1/4" MNPT. 10/box.
		346	3/8" MNPT x 1/4" MNPT. 10/box.
		366	3/8" MNPT x 3/8" MNPT. 10/box.
		388	1/2" MNPT x 1/2" MNPT. 10/box.

Female Couplings

21-515	1/4" FNPT x 1/4" FNPT. Carded. 5/master.
344F	1/4" FNPT x 1/4" FNPT. 10/box.

Female Bushings

324F	1/8" FNPT x 1/4" MNPT. 10/box.
342F	1/4" FNPT x 1/8" MNPT. 10/box.
21-535	1/4" FNPT x 3/8" MNPT. Carded. 5/master.
346F	1/4" FNPT x 3/8" MNPT. 10/box.
348F	1/4" FNPT x 1/2" MNPT. 10/box.
364F	3/8" FNPT x 1/4" MNPT. 10/box.
368F	3/8" FNPT x 1/2" MNPT. 10/box.

Reducer Adapter

21-544	3/8" FNPT x 1/4" MNPT. 10/box.
---------------	--------------------------------

Ball-End Adapters

21-595	1/4" MNPT x 1/4" MNPS with ball socket. Carded. 5/master.
21-597	1/4" MNPT with ball socket x 1/4" MNPS with ball socket. Carded. 10/master.

Drain Cocks. 150 PSI.

931	1/8" Drain Cock. 10/box.
21-555	1/8" Drain Cock. Carded. 10/master.
21-557	1/4" Drain Cock. Carded. 10/master.
930	1/4" Drain Cock. 10/box.

Reusable Hose Fittings

Eliminates the need for hose clamps or ferrules. Heavy duty construction. Designed for fast, easy, yet permanent air-tight connections.

418	1/2" Hose OD, 1/4" Hose ID, 1/4" MNPT. 10/box.
22-123	19/32" Hose OD, 1/4" Hose ID, 1/4" MNPT. Carded. 10/master.
419	10/box.
22-133	5/8" Hose OD, 1/4" Hose ID, 1/4" MNPT. Carded. 5/master.
620	10/box.
22-162	11/16" Hose OD, 3/8" Hose ID, 1/4" MNPT. 5/box.
22-163	11/16" Hose OD, 3/8" Hose ID, 1/4" MNPT. Carded. 10/master.
623	3/4" Hose OD, 3/8" Hose ID, 1/4" MNPT. 10/box.
828	7/8" Hose OD, 1/2" Hose ID, 1/2" MNPT. 10/box.

Female Crosses

Excellent for running several air lines from a common source. Solid brass.

344X	1/4" NPT. 10/box.
366X	3/8" NPT. 10/box.

■ *Tru-Flate Part No.*

■ *Amflo Part No.*

Female Tees

Excellent for running 2 air lines from a common source. Solid brass.

344T	1/4" NPT. 10/box.
366T	3/8" NPT. 10/box.



Female Tee

3-Way Manifolds

Supply 3 air tools from one source. Use on air hose end or as permanently fixed bench outlet. No need to disconnect/connect to use different tools.

Machined aluminum construction

41-125 1/4" FNPT inlet x 1/4" FNPT outlet. Carded. 5/master.

1/4" FNPT inlet x 1/4" FNPT outlet.

3404-RET	Carded. 5/master.
3404	1/box.

3/8" FNPT inlet x 1/4" FNPT outlet.

3406	1/box.
-------------	--------

1/2" FNPT inlet x 1/4" FNPT outlet.

3408	1/box.
-------------	--------

Flat brass construction

41-126 3/8" FNPT inlet x 1/4" FNPT outlet. 1/box.



3-Way Manifold (Brass)



3-Way Manifold (Aluminum)

In-Line Swivel Fittings

Permits rotation of fitting without kinking or twisting of hose.

344R	1/4" male/female NPT. 10/box.
366R	3/8" male/female NPT. 300 PSI. 10/box.



In-Line Swivel Fitting

Uniswivel Fitting

Full 360° swivel action. 300 PSI.

1/4" MNPT x 1/4" FNPT.

21-607 10/master.

344U	10/box.
-------------	---------



Uniswivel Fitting

Safety Valves

Constructed to ASME standards. Interchangeable with all other ASME valves of the same size and pressure. Furnished with relief pressure preset.

21-707 1/4" Safety Valve 125 PSI. Carded. 5/master.

21-709 1/4" Safety Valve 150 PSI. Carded. 5/master.



Safety Valve

Replacement Fitting Kits

Each kit includes fitting, nut insert, ferrule and spring guard - Nylon.

4-0	For 1/4" I.D. hose. 10/bag.
6-0	For 3/8" I.D. hose. 10/bag.
8-0	For 1/2" I.D. hose. 10/bag.

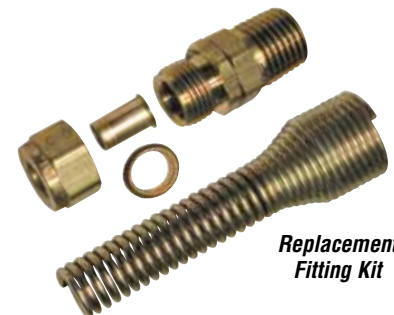

Replacement Fitting Kit

Air Line Hook-Up Hints

Proper usage of compressed air power calls for filters to clean the air, regulators to control pressure, gauges to show pressure and lubricators to protect power tools. Air line systems also need hose and tubing to provide flexibility at the points of use. Couplers, plugs and fittings are the components that complete the systems for quick, easy, secure fastening to paint spray guns, blowguns, inflator gauges, chucks, power tools and pneumatic tire repair stands. Amflo® and Tru-Flate® components offer reliable, low-cost, readily available, proven ways to hook up your air line system.



LEADER HOSE
A short length of leader hose is recommended on a paint spray gun to keep the coupler and plug from scratching a painted surface.



DESICCANT AIR DRYERS
Deliver extremely clean, dry air to pneumatic system components. The use of desiccants will optimize the quality of compressed air to improve performance of air tools and ensure oil-free, dry air to auto paint spray equipment.

SAFETY BLOWGUNS
To comply with OSHA requirements, blowguns used on UNREGULATED air lines must be capable of restricting nozzle pressure to 30 PSI or less when dead-ended.



DIRECT AIR LINE CHUCKS



AIR HOSE

AIR LINE FILTERS
ALWAYS LOCATE YOUR FILTER AS FAR FROM THE COMPRESSOR AS POSSIBLE IN ORDER TO TRAP AS MUCH CONDENSATION AS POSSIBLE.

Amflo and Tru-Flate two-stage filters remove liquids, oil, water and large dust particles by centrifugal force, and small dust particles down to 40 microns by a porous element filter. Air line filters are vital to protect expensive air powered tools to keep them operating longer with greater efficiency.



INFLATOR GAUGES



INLINE TOOL FILTER

TIRE HARDWARE



PRESSURE GAUGES

TANK VALVES



Air Line Hook-Up Hints

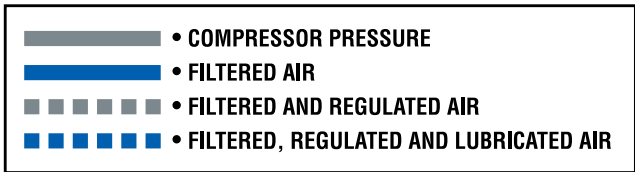

AT-HAND® REGULATOR
Regulator allows custom pressure settings for various tools without having to go back to the compressor.

PRESSURE REGULATORS
Pressure regulators reduce line pressure to a usable range – a lower pressure than the compressor is set to deliver. Regulators maintain a steady flow of air regardless of the fluctuations that may take place in line pressure.

Pressure regulators should be used on air lines which feed impact wrenches in order to control tightening torque AND ON ALL AIR LINES THAT FEED STANDARD BLOWGUNS TO COMPLY WITH OSHA REGULATIONS. Regulators must be set at 30 PSI or less.



AIR LINE LUBRICATORS
MODERN AIR POWERED TOOLS NEED LUBRICATION! Lubricators protect expensive power tools. Ultrasonic generators deliver oil in a fine mist form. Lubricators are simple to adjust. Loading bowl can be filled from either side.

ALWAYS LOCATE LUBRICATOR AS CLOSE TO THE TOOL AS POSSIBLE. NEVER LOCATE A LUBRICATOR BETWEEN A COMPRESSOR AND FILTER REGULATOR, OR ON AN AIR SUPPLY LINE TO A PAINT GUN.



AIR LINE FILTERS



COMBINATION FILTER/REGULATORS
This unit is equipped with an automatic drain, providing the user with a clean, moisture-free air supply and saving money too!

The large filter surface area minimizes pressure drop, and is RECLEANABLE. The regulator portion of the unit is extremely stable in low-flow applications, and a balanced valve design prevents secondary pressure changes with fluctuating primary pressures.

This unit should always be located as far away from the compressor as possible.



BRASS THREAD ADAPTERS



RECOIL AIR HOSE
Self-retracting nylon or poly air hose is ideal for hook-up to portable air powered tools. By recoiling, it keeps "out from underfoot" by itself.



STANDARD BLOWGUNS
Must be used on PRESSURE REGULATED lines in order to comply with OSHA requirements. Set regulator at 30 PSI or less.



LEADER HOSE

RECOMMENDED AIR POWERED TOOL HOOK-UP
Air powered tools such as impact wrenches and panel cutters generate intermittent shock loads to make them work. If a coupler and plug are installed directly to the tool, this can cause PREMATURE FAILURE of the coupler.

ALWAYS USE A SHORT LENGTH OF LEADER HOSE BETWEEN THE TOOL AND THE COUPLER AND PLUG TO ABSORB AS MUCH OF THE SHOCK AS POSSIBLE.

FOR ANY APPLICATION, USE SLEEVE-TYPE COUPLER

FOR WALL MOUNT ONLY, USE PUSH-TYPE COUPLER

COUPLERS AND PLUGS

BARB-TYPE HOSE FITTINGS

HOSE FITTINGS

AIR POWERED TIRE BUFFER



TRU-FLATE® Filters, Regulators & Lubricators



Filter / Regulator Combinations (Piggyback)

Accurate pressure regulation with maximum water and dirt separation, provided in a single, compact unit. The filter significantly increases the life of expensive equipment, such as air line tools, valves, cylinders and motors. The regulator employs a solid piston, which resists rupture, cracking or tearing under pressure or high cycle rates. Combination Filter/Regulators have 2 gauge ports and come complete with filter element, pressure gauge and locking knob adjustment. Maximum pressure (polycarbonate bowls): 150 PSI at 125° F primary, 2 to 125 PSI secondary. Maximum pressure (metal bowls): 250 PSI at 175° F primary, 5 to 250 PSI secondary. Temperature range: -10° F to +175° F.

Part No.	Series	Quantity	Port	SCFM†	Drain Type	Microns	Capacity	Bowl Type	Height (in.)
24-243	Mini	2/master*	1/4"	13	Manual	5	1 oz.	Poly	5.7
24-244	Mini	1/box	1/4"	13	Automatic	5	1 oz.	Poly	6.1
24-201	Compact	1/box	1/4"	55	Manual	40	5 oz.	Poly	10.4
24-211	Compact	1/box	3/8"	65	Manual	40	5 oz.	Poly	10.4
24-221	Standard	1/box	1/2"	105	Manual	40	5 oz.	Poly	12.1
24-222	Standard	1/box	1/2"	105	Automatic	40	8 oz.	Poly	12.1
24-231	Standard	1/box	3/4"	110	Manual	40	8 oz.	Poly	12.1

*Retail clamshell package †Standard cubic feet per minute with 100 PSI inlet pressure, 80 PSI no flow secondary setting and 10 PSI pressure drop.



Air Line Filters

Tru-Flate® Air Line Filters are used for all air line applications where efficient filtration is required. Filtration removes airborne solid contaminants, pipe scale, rust, condensate, etc., which may cause wear or failure of pneumatic components. Large filter element surface gives low pressure drop and long element life. The Mini series of air line filters offers a higher degree of filtration. All filters are complete with filter element and either manual or automatic drains. Maximum pressure: 150 PSI at 125° F with polycarbonate bowl and 250 PSI at 175° F with metal bowl. Temperature range: -10° F to +175° F.

Part No.	Series	Quantity	Port	SCFM†	Drain Type	Microns	Capacity	Bowl Type	Height (in.)
24-343	Mini	2/master*	1/4"	20	Manual	5	1 oz.	Poly	3.7
24-301	Compact	2/master*	1/4"	50	Manual	40	5 oz.	Poly	6.1
24-304	Compact	2/master*	1/4"	50	Automatic	40	5 oz.	Metal	6.4
24-311	Compact	2/master*	3/8"	75	Manual	40	5 oz.	Poly	6.1
24-321	Standard	1/box	1/2"	110	Manual	40	8 oz.	Poly	7.7
24-322	Standard	1/box	1/2"	110	Automatic	40	8 oz.	Poly	7.7
24-331	Standard	1/box	3/4"	125	Manual	40	8 oz.	Poly	7.7
24-351	Hi-Flow	1/box	1"	300	Manual	40	18 oz.	Metal	10.95

*Retail clamshell package †Standard cubic feet per minute with 100 PSI inlet pressure with 5 PSI pressure drop.

Air Line Regulators

Tru-Flate® Air Line Regulators employ a solid piston and balanced poppet for excellent performance and longer life. The solid piston design is reliable for a broad range of demanding applications and is impervious to a wide range of lubricating oils and greases. Unlike diaphragms, the solid piston resists rupture, cracking or tearing under pressure, constant flexing or high cycle rates. It is impervious to most chemicals, provides accurate control and assures smooth, uninterrupted operation. Tru-Flate Air Line Regulators have fast reverse flow capabilities, allowing installation where dual pressures are required. Feature 2 gauge ports and include pressure gauge and non-rising, locking knob adjustment. Maximum pressure: 250 PSI primary, 2 to 125 PSI secondary.

Part No.	Series	Quantity	Port	SCFM†	Height (in.)
24-444	Mini	2/master*	1/4"	13	2.9
24-404	Compact	2/master*	1/4"	55	6.4
24-414	Compact	2/master*	3/8"	70	6.4
24-424	Standard	1/box	1/2"	110	7.3
24-434	Standard	1/box	3/4"	130	7.3
24-454	Hi-Flow	1/box	1"	300	8.46

*Retail clamshell package



Air Line Lubricators

Tru-Flate Air Line Lubricators are designed to provide proportional delivery of lubricating oil over a wide range of air flows. Ideal for most general applications. Externally adjustable with transparent sight dome for 360° visibility. Lubricator should be mounted as close as possible to application to ensure most effective distribution of oil to pneumatic components. Suggested lubricant: Petroleum-based oil of 100 to 200 SSU viscosity at 100° F and an aniline point greater than 200° F.

Except for the Mini series, Tru-Flate Air Line Lubricators may be filled while the system is under pressure. Maximum pressure: 150 PSI at 125° F with polycarbonate bowl. Temperature range: -10° F to +175° F. For pressures up to 250 PSI at 175° F, a metal replacement bowl must be ordered and installed separately. Metal bowls with sight glass are standard for the Hi-Flow Series.

Part No.	Series	Quantity	Port	SCFM†	Capacity	Bowl Type	Height (in.)
24-542	Mini	1/box	1/4"	11	1 oz.	Poly	5.2
24-501	Compact	1/box	1/4"	20	5 oz.	Poly	7.4
24-511	Compact	1/box	3/8"	35	5 oz.	Poly	7.4
24-521	Standard	1/box	1/2"	85	8 oz.	Poly	8.9
24-531	Standard	1/box	3/4"	90	8 oz.	Poly	8.9
24-551	Hi-Flow	1/box	1"	260	18 oz.	Metal	11.81



WARNING: Oils with adhesives, compounded oils containing solvents, graphite, detergents or synthetic oils must not be used.

†Standard cubic feet per minute at 10 PSI with 5 PSI pressure drop.



56-081

Dessicant Dryers

Our in-line desiccant dryers are engineered to deliver extremely dry compressed air to protect pneumatically operated equipment from the adverse effects of moisture. Maximum rated operating conditions – Metal bowl with sight glass: 250 PSIG (17.2 Bar); 120°F (48°C).

Part No.	Port	Bowl	Flow Rate	Max. Pressure	Quantity
56-081	1/2"	1 qt.	10 SCFM†	300 PSI	1/box

WARNING: These dryers are intended for use in compressed air systems only. Do not use where pressure or temperature may exceed maximum rated operating conditions. These units are not to be used on life support systems or breathing air systems. Failure to follow the recommendations contained in this warning may result in personal injury and/or property damage.

56-082 Replacement Beads. 1 qt.



56-082



24-603

Coalescing Oil Removal Filter

Removes more than 99.9% of liquid aerosols – oil or water – from pneumatic systems. Removes submicron – 0.3 micron – contaminants. For all critical applications where oil-free air is required. Liquids gravitate to bottom of element and re-entry into pneumatic system is prevented. Placing a Tru-Flate® Air Line Filter upstream from the Oil Removal Filter to act as a pre-filter will increase the life of the coalescing element and is recommended. Maximum pressure: 150 PSI at 125° F.

Part No.	Series	Size	SCFM†	Capacity	Height
24-603	Standard	1/2" NPTF	20	8 oz.	7.9

Air Line Pressure Gauges

Pressed steel case with shatterproof crystal and brass fitting. Used for air, water, oil, or other fluids compatible with brass and bronze. Nominal accuracy 3-2-3%. 1/box.



24-807
24-811



24-801
24-803
24-804

Part No.	Mount	Quantity	Thread	PSI Range
24-801	Back	1/box	1/8" NPT	0-200
24-803	Back	1/box	1/4" NPT	0-160
24-804	Back	1/box	1/4" NPT	0-300
24-807	Bottom	1/box	1/4" NPT	0-160
24-811	Bottom	1/box	1/4" NPT	0-300

*Retail clamshell package

†Standard cubic feet per minute with 100 PSI inlet pressure with 5 PSI pressure drop.

Replacement Parts and Accessories

Each sold individually, either boxed or in retail bags.

Product	Mini	Compact	Standard	Hi-Flow
Filter Element Kits Includes one element and all necessary O-ring seals.				
5 Micron	24-934	-	-	-
40 Micron	-	24-932	24-939	24-930
5 SCFM (rated)	-	24-940	-	-
20 SCFM (rated)	-	-	24-943	-
Polycarbonate Bowls	-	24-901	24-902	-
Metal Bowls	-	24-903	24-910	-
Polyethylene Bowl Guard Kit For applications where polycarbonate bowls may be subjected to impact or rougher than normal usages.	-	24-911	24-912	-
Automatic Float Drain Kit	-	24-920	24-920	24-920
Mounting Brackets Kits are designed to permit wall mounting of Compact, Standard and Hi-Flow Series Filters and Regulators.				
Lubricators & Filters	24-950	24-956	24-957	24-958
Regulators & Piggyback	24-950	-	24-955	24-958



Filter Element Kit



Polycarbonate Bowl



Metal Bowl



Mounting Bracket



Automatic Float Drain



Bowl Guard

In-Line Air Tools



41-101



1212



41-135

97-953



41-145



1200

■ Tru-Flate Part No.

■ Amflo Part No.

In-Line Air Tool Oiler

A compact oiler that fastens directly to the air tool. Precisely meters proper amount of oil to the tool only when the tool is in use. No adjustments necessary. 1/4" male NPT outlet, 1/4" female NPT inlet. Use on all air impact guns, air wrenches, body shop air tools and pneumatic hammers requiring 1/4" air lines. Note: Never use motor oil in pneumatic tool. **Prevents "burn-out" of expensive pneumatic tools, stops rust and increases torque up to 25%.**

41-101 Carded. 10/master.

In-Line Air Flow Regulator

Controls in-line air pressure for paint spray guns or other pneumatic tools. Helps keep air flow at exact operating pressures. Use where precise air flow is desired. Compact, lightweight design with gauge, allows for easy "on the tool" air adjustment.

41-135 Carded. 5/master.

97-953 Replacement Gauge 1/box.

At-Hand® In-Line Air Tool Regulator

Designed for demanding professional and pressure-sensitive tools, this durable regulator may be used to adjust air pressure at the tool without going back to the air compressor. Installation at the tool air inlet allows easy access to change the inlet air pressure. The regulator also provides an easy-to-read scale that allows pressure adjustment from the air tank to the tool for any pressure between 40-140 PSI.

41-145 Clamshell. 5/master.

1200 1/box.

■ *Tru-Flate Part No.*

■ *Amflo Part No.*

Tamperproof In-Line Regulators

Tamperproof fixed pressure setting preset at the factory – can be installed with safety in mind. Balanced Popet design will not chatter or drift, so outlet setting will not change even when inlet pressure varies. High flow capability can be restricted for low flow requirements. Streamlined low-profile shape for neat installation and space saving requirements. Easy to install, no brackets or special tools required. Regulator will function in any position. High-strength aluminum alloy construction, anodized for corrosion protection and color coded. Other settings available upon request.

1/4" NPTF. Regulator inlet rating 400 PSI. Unit only delivers line pressure. Delivery pressure is a function of flow.

- 2111** 70 PSI. Gold band. 1/box.
- 2112** 90 PSI. Red band. 1/box.
- 2113** 100 PSI. Silver band. 1/box.
- 2114** 110 PSI. Brass band. 1/box.



2111



2112

2113

2114

In-Line Air Tool Filter

A compact and extremely effective accessory for all air-operated shop tools and equipment, such as inflator gauges, impact wrenches, spray guns, air powered sanders, etc. Protects them against rust, pipe scale and dirt. 1/4" female NPT inlet, 1/4" male NPT outlet. Sintered bronze filter element. Maximum working pressure 500 PSI. **Reduces downtime, prevents expensive repairs and prolongs the life of pneumatic tools.**

41-150 Carded. 10/master.

97-652 Replacement Filter Element. 1/bag.



41-150



1027



97-652

Filter / Regulator Combinations (Piggyback)



Mini



Standard

Accurate pressure regulation with maximum water and dirt separation, provided in a single, compact unit. The filter significantly increases the life of expensive equipment, such as air line tools, valves, cylinders and motors. The regulator employs a solid piston, which resists rupture, cracking or tearing under pressure or high cycle rates. Combination Filter/Regulators have 2 gauge ports and come complete with filter element, pressure gauge and locking knob adjustment. Maximum pressure (polycarbonate bowls): 150 PSI at 125° F primary, 5 to 125 PSI secondary. Maximum pressure (metal bowls): 250 PSI at 175° F primary, 5 to 250 PSI secondary. Temperature range: -10° F to +175° F.

Part No.	Series	Quantity	Port	SCFM†	Capacity	Bowl Type
4300D	Mini	1/master*	1/4"	20	1 oz.	Poly
4300	Mini	1/box	1/4"	20	1 oz.	Poly
4310A-99	Standard	1/box	1/4"	75	5 oz.	Poly
4320A-99	Standard	1/box	3/8"	75	5 oz.	Poly
4330	Standard	1/box	1/2"	150	8 oz.	Poly w/ Metal Guard
4331	Standard	1/box	1/2"	150	8 oz.	Metal
4340	Standard	1/box	3/4"	150	8 oz.	Poly w/ Metal Guard
4341	Standard	1/box	3/4"	150	8 oz.	Metal



Mini



Compact

†Standard cubic feet per minute with 100 PSI inlet pressure, 80 PSI no flow secondary setting and 10 PSI pressure drop.

Air Line Filters

Amflo® Air Line Filters are used for all air line applications where efficient filtration is required. Filtration removes airborne solid contaminants, pipe scale, rust, condensate, etc., which may cause wear or failure of pneumatic components. Large filter element surface gives low pressure drop and long element life. The Mini series of air line filters offers a higher degree of filtration. All filters are complete with filter element and either manual or automatic drains. Maximum pressure: 150 PSI at 125° F with polycarbonate bowl and 250 PSI at 175° F with metal bowl. Temperature range: -10° F to +175° F.



Standard



Hi-Flow

Part No.	Series	Quantity	Port	SCFM†	Drain Type	Microns	Capacity	Bowl Type
3000	Mini	1/box	1/4"	21	Manual	5	1 oz.	Poly
4010A-99	Compact	1/box	1/4"	21	Manual	40	5 oz.	Poly
4011A-99	Compact	1/box	1/4"	21	Manual	40	5 oz.	Metal
4020A-99	Compact	1/box	3/8"	70	Manual	40	5 oz.	Poly
4021A-99	Compact	1/box	3/8"	70	Manual	40	5 oz.	Metal
4030	Standard	1/box	1/2"	150	Manual	40	8 oz.	Poly
4031	Standard	1/box	1/2"	150	Manual	40	8 oz.	Metal
4032	Standard	1/box	3/4"	150	Manual	40	8 oz.	Poly
4040	Standard	1/box	3/4"	150	Manual	40	8 oz.	Metal
4041	Hi-Flow	1/box	3/4"	425	Manual	40	8 oz.	Metal
4050	Hi-Flow	1/box	1"	425	Manual	40	8 oz.	Metal

†Standard cubic feet per minute with 100 PSI inlet pressure, 80 PSI no flow secondary setting and 10 PSI pressure drop.

*Retail display package.

Air Line Regulators

Amflo® Air Line Regulators employ a solid piston and balanced poppet for excellent performance and longer life. The solid piston design is reliable for a broad range of demanding applications and is impervious to a wide range of oils and greases. Amflo Air Line Regulators have fast reverse flow capabilities, allowing installation where dual pressures are required. Maximum inlet pressure: 300 PSI. Temperature range: 0° F to +150° F (Mini and Compact), 0° F to +175° F (Standard). Gauge not included.

Part No.	Series	Quantity	Port	SCFM†
4100	Mini	1/box	1/4"	20
4102	Mini	1/box	1/4"	20
4115A-99	Standard	1/box	1/4"	70
4125A-99	Standard	1/box	3/8"	70
4135	Standard	1/box	1/2"	150
4145	Standard	1/box	3/4"	150
4141	Standard	1/box	3/4"	150
4155	Standard	1/box	1"	425



Mini



Compact



Standard

†Standard cubic feet per minute with 100 PSI inlet pressure, 80 PSI no flow secondary setting and 10 PSI pressure drop.

Air Line Lubricators – Micro Fog

Amflo® Air Line Lubricators are designed to provide proportional delivery of lubricating oil over a wide range of air flows and are ideal for most general applications. Micro Fog has droplet size of less than 2 microns, has finer control and the oil will travel greater distances. Lubricator is externally adjustable with a transparent sight dome for 360° visibility. Maximum pressure: 150 PSI at 125° F with polycarbonate bowl, 250 PSI at 175° F with metal bowl.

Part No.	Series	Quantity	Port	SCFM†	Capacity	Bowl Type
4200D	Mini	1/master*	1/4"	5	1 oz.	Poly
4200	Mini	1/box	1/4"	5	1 oz.	Poly
4215A-99	Standard	1/box	1/4"	35	5 oz.	Poly
4225A-99	Standard	1/box	3/8"	35	5 oz.	Poly
4235	Standard	1/box*	1/2"	150	8 oz.	Poly w/ Metal Guard
4236	Standard	1/box	1/2"	150	8 oz.	Metal
4245	Standard	1/box	3/4"	150	8 oz.	Poly w/ Metal Guard



Mini



Standard

WARNING: Oils with adhesives, compounded oils containing solvents, graphite, detergents or synthetic oils must not be used.

†Standard cubic feet per minute at 10 PSI with 5 PSI pressure drop.

*Retail display package.



Air Line Lubricators – Oil Fog

Amflo® Air Line Lubricators are designed to provide proportional delivery of lubricating oil over a wide range of air flows and are ideal for most general applications. Oil Fog has droplet size of greater than 2 microns, for applications over short distances. Most can be filled while system is still under pressure. Maximum pressure: 150 PSI at 125° F with polycarbonate bowl, 250 PSI at 175° F with metal bowl.

Part No.	Series	Quantity	Port	SCFM†	Capacity	Bowl Type
4210A-99	Standard	1/box	1/4"	35	5 oz.	Poly
4211A-99	Standard	1/box	1/4"	35	5 oz.	Metal
4220A-99	Standard	1/box	3/8"	35	5 oz.	Poly
4230	Standard	1/box	1/2"	150	8 oz.	Poly w/ Metal Guard
4231	Standard	1/box	1/2"	150	8 oz.	Metal
4240	Standard	1/box	3/4"	150	8 oz.	Poly w/ Metal Guard
4241	Standard	1/box	3/4"	150	8 oz.	Metal
4250	Standard	1/box	1"	425	18 oz.	Metal



Mini

WARNING: Oils with adhesives, compounded oils containing solvents, graphite, detergents or synthetic oils must not be used.
†Standard cubic feet per minute at 10 PSI with 5 PSI pressure drop.

FRL Combo Units

The function of a Filter, Regulator and Lubricator in one convenient unit. Maximum pressure: 150 PSI at 125° F with polycarbonate bowl, 250 PSI at 175° F with metal bowl.

Part No.	Series	Quantity	Port	SCFM†	Capacity	Bowl Type
4405	Mini	1/box	1/4"	5	1 oz.	Poly
4410A-99	Standard	1/box	1/4"	75	5 oz.	Poly
4420A-99	Standard	1/box	3/8"	75	5 oz.	Poly
4431	Standard	1/box	1/2"	150	8 oz.	Metal



Standard

Replacement Parts and Accessories

Filter Element Kits

- 3063** 3/8" Mini Filter Element Kit, 5 micron. 1/bag.
- 4062** Mini Filter Element, 5 micron. 1/bag.
- 4066A-99** 3/8" Standard Filter Element, 40 micron. 1/bag.
- 4092** 1/2" Standard Filter Element, 5 micron. 1/bag.
- 4093** 1/2" Standard Filter Element, 40 micron. 1/bag.
- 4068** 1" Standard Filter Element, 40 micron. 1/bag.



Filter Element Kit

Replacement Parts and Accessories (cont.)

Drain Kits

- 4060** Automatic Drain. 1/bag.
- 4070** 3/8" Automatic Drain. 1/bag.
- 4096** Manual Drain Kit. 1/bag.
- 4085** Manual Drain Repair Kit, T-Handle Type. 1/bag.



Drain Kits

Replacement Bowls

- 4073** Mini Polycarbonate Bowl. 1/box.
- 4074A-99** 3/8" Polycarbonate Bowl. 1/box.
- 4095** 1/2" Polycarbonate Bowl. 1/box.
- 4079A-99** 3/8" Metal Bowl. 1/box.
- 4094** 1/2" Metal Bowl. 1/box.
- 4264** Mini Polycarbonate Bowl, for Lubricator. 1/box.
- 4265A-99** 3/8" Polycarbonate Bowl, for Lubricator. 1/box.
- 4270A-99** 3/8" Metal Bowl, for Lubricator. 1/box.
- 4285** 1/2" Polycarbonate Bowl, for Lubricator. 1/box.



Metal Bowl



Polycarbonate Bowl

Bowl O-Rings

- 4780** Mini Bowl O-Ring. 1/bag.
- 4782** 3/8" Bowl O-Ring. 1/bag.
- 4783** 1/2" Bowl O-Ring. 1/bag.



Bowl O-Ring



Panel Nut

Panel Nuts

- 3161** Mini Filter Panel Nut. 1/bag.
- 4161** Mini Regulator Panel Nut. 1/bag.
- 4773** Zinc Panel Mount Nut. 1/bag.
- 4778** 3/8" Panel Nut. 1/bag.

Replacement Domes

- 4282** Adjustment Dome, Oil Fog Lubricators. 1/box.



Replacement Dome

Mounting Brackets

- 3071** 3/8" Mounting Bracket. 1/bag.
- 4071A-99** 3/8" Mounting Bracket. 1/bag.
- 3162** 3/8" Mounting Bracket. 1/bag.
- 4160** Mini Mounting Bracket. 1/bag.
- 4162A-99** 3/8" Mounting Bracket. 1/bag.
- 4165** 1" Mounting Bracket. 1/bag.
- 4760** Universal Wall Bracket for 1/4" Compact Series. 1/bag.
- 4772** Universal Wall Bracket for 1/2" Modular Series. 1/bag.

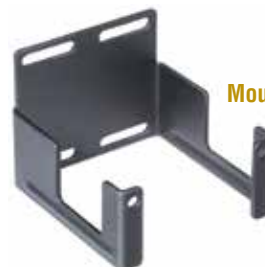

Mounting Brackets

Replacement Parts and Accessories (cont.)



Quick-Clamp

Quick-Clamps

- 4761** Quick-Clamp for Compact Series. 1/bag.
- 4769** Quick-Clamp for 1/2" Modular Series. 1/bag.
- 4771** Quick-Clamp with Wall Bracket for 1/2" Modular Series. 1/bag.

Repair Kits

- 4169** 1" Regulator Repair Kit. 1/bag.
- 4776** 1/2" Regulator Repair Kit. 1/bag.



Regulator Repair Kit

Air Line Pressure Gauges

Pressed steel case with shatterproof crystal and brass fitting. Used for air, water, oil, or other fluids compatible with brass and bronze. Nominal accuracy 3-2-3%.



Bottom Mount Gauge



Back Mount Gauge

Part No.	Mount	Quantity	Thread	PSI Range
1012-15	Bottom	1/box	1/4" NPT	0-15
1012-160	Bottom	1/box	1/4" NPT	0-160
1012-300	Bottom	1/box	1/4" NPT	0-300
1101-60	Back	1/box	1/8" NPT	0-60
1101-160	Back	1/box	1/8" NPT	0-160
1111-160	Back	1/box	1/8" NPT	0-160
1112-160D-RET	Back	5/master*	1/4" NPT	0-160
1112-160	Back	1/box	1/4" NPT	0-160
1112-300	Back	1/box	1/4" NPT	0-300

*Carded display package

■ Amflo Part No.

Lubricants

92 SUS at 75° F. Air Tool Oil is silicone-free.

- 1220-1** Air Tool Oil. 1 pint bottle. 12/master.
- 1220-4** Air Tool Oil. 4 oz. bottle (not shown). 12/master.
- 1220-8** Air Tool Oil. 1 gallon bottle. 4/master.
- 1420** Compressor Oil. 1 quart bottle. 12/master.

Ball Valves

For all commercial and general industrial applications. Pressure rating 600 PSI, steam rating 150 WP, temperature range -20°F to 370°F.

- 1302** 1/4" FNPT. 1/box.
- 1303** 3/8" FNPT. Bulk. 1/box.
- 1304** 1/2" FNPT. 1/box.

Specialty Valves

For air tanks, steel barrels, compressors and other pneumatic containers where dependable automatic air valves are needed.

Throttle Valve

Controls air flow from near shut-off to full flow. Knurled knob is graduated. Spring-loaded ball and detent hold setting. Solid brass construction.

- 235** 1/4" FNPT. 1/box.

Two-Way Lever Valve

Chrome plated die-cast body. Buna-N seals for air and water.

- 240** 1/4" FNPT. 1/box.
- 240-100** 1/4" FNPT. Bulk. 100/box.

Three-Way Slide Valve

Heavy duty fast acting in-line valve for air and fluid shut off. Plated construction with knurled sleeve allows easy movement forward and back.

- 260** 1/4" FNPT. 1/box.

High Pressure Inflating Connections

These high-pressure inflating connections attach securely by hand or wrench to the valve cap threads of high pressure valves. Can be fitted to gauging and inflating devices by a variety of methods. Various angles permit easy attachment to hard-to-reach valves.

- 2755** For 3/16" flare tube. 3/8"-24 thread. 1/box.
- 2755-26** Replacement washer for 2755 (not shown). 100/box
- 556** 90° angle. Copper sealing washer. 1/8" MNPT. 1/box.
- 5784** 70° angle. 7/16"-20 thread for 1/4" flare tube fitting. 1/box.
- 6116** 70° angle. Hard fiber sealing washer. 1/8" FNPT. 10/box.

WARNING: Valves on this page are intended for compressed air lines or water lines only. All have a maximum rated pressure of 300 PSI unless otherwise noted.



1220-1

1220-8

1420



1302
1303
1304



235



240



260



2755/556



5784



6116

Inflating
Connections

Air Accessories

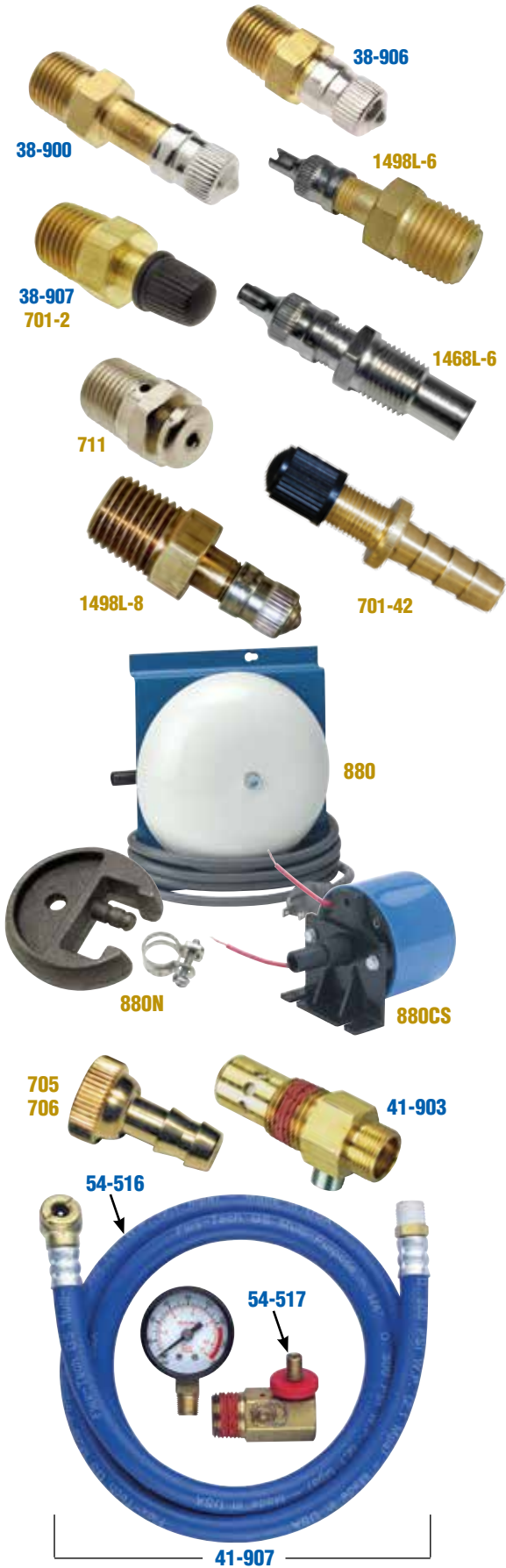

■ *Tru-Flate Part No.*

■ *Amflo Part No.*

Tank Valves

For air tanks, steel barrels, compressors and other pneumatic containers where dependable automatic air valves are needed. Equipped with standard valve core and sealing caps for operating pressures to 200 PSI. Allow for external length variations by use of short core only or internal protrusion of core housing into container.

38-906	1/8" MNPT. Carded. 10/master.
700	1/8" MNPT. 10/box.
700-100	1/8" MNPT. Bulk. 100/box.
38-900	1/8" MNPT, long. Carded. 5/master.
38-900-10	1/8" MNPT, long. 10/box.
701	1/8" MNPT, long. 10/box.
701-100	1/8" MNPT, long. Bulk. 100/box.
38-907	1/4" MNPT. Carded. 5/master.
701-2D	1/4" MNPT. Carded. 10/master.
701-2	1/4" MNPT. 10/box.
701-2-100	1/4" MNPT. Bulk. 100/box.
701-42	1/4" ID Hose Barb. 10/box.
1468L-6	1/8" MNPT. 25/box.
1498L-6	1/4" MNPT. 25/box.
1498L-8	1/4" MNPT. Bulk. 250/box.

Bleeder Valves

Simple push-button for bleeding compressed air lines or liquid systems.

710-100	.310-32 thread. Bulk. 100/box.
711	1/8" MNPT. 10/box.
711-100	1/8" MNPT. Bulk. 100/box.

Driveway Signal Bell

Bell rings when auto tire passes over the hose. Easy to install and wire.

Driveway signal bell. 110 volt. 3 wire ground cord.

880	1/box.
Replacement control switch. 110 volt.	
880CS	1/box.
Hose anchor and plug. For 3/8" ID Signal Hose.	
880N	1/box.

Bicycle Pump Fittings

Screw-on swivel chuck for most hand-operated tire pumps.

705	3/16" ID. 10/box.
705-100	3/16" ID. Bulk. 100/box.
706	1/4" ID. 10/box.
706-100	1/4" ID. Bulk. 100/box.

Compressor Repair Parts

1/2" Air Tank Check Valve

41-903 Carded. 10/master.

Air Tank Conversion Kit. Includes gauge, manifold and hose with fittings.

41-907 Carded. 5/master.

■ *Tru-Flate Part No.*

■ *Amflo Part No.*

Compressor Repair Parts (cont.)

Shown on page 48

54-516 Replacement Hose with Fittings. 1/box.

54-517 Replacement Manifold. 1/box.

Compressor Accessory Kit

Perfect for the do-it-yourselfer! 19-piece kit contains all accessories needed to connect and use a tank-mounted air compressor.

- Couplers/Plugs for air line hose and air tool connections
- Air Line Chuck for filling tire valves
- Tire Gauge, to check air pressure
- Blowgun Kit with multiple nozzles for general cleaning and drying
- Ball and tapered nozzles for inflating toys and recreational equipment

41-175 Carded. 5/master.



Hose Repair Kit

Contains all parts necessary to repair a direct air line hose assembly.

- Single Foot Air Chuck, 1/4" Female NPT
- Male Hose End Fitting, 1/4" ID hose x 1/4" NPT
- Hose Splicer, 1/4" ID hose
- 3 Hose Clamps, fits 3/8" ID hose

41-300 Carded. 5/master.

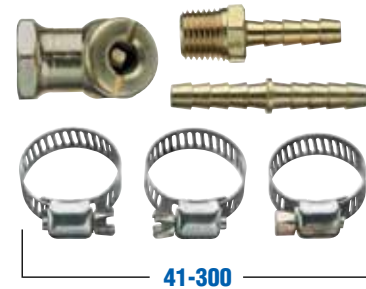

Water / Radiator Valves

Features chrome plated bodies with brass internal parts and self-adjusting U-cup packing. Handles are riveted and spouts are reinforced for long life. Lever controlled operating valve. Alkali, heat, oil and weather resistant.

18-501 Water Nozzle. Carded. 5/master.
43W 1/box.

Radiator Faucet. Aluminum. 1/4" FNPT.
40 1/box.

Radiator Faucet Valve Kit (not shown).
40-205RK 1/bag.

18-504 Radiator Filler. Rubber Nozzle. 3/4" Female Garden Bibb. 1/box.

18-506 Radiator Faucet. Rubber Nozzle. 1/4" FNPT. 1/box.
40RD Display Pack. 1/box.
40R 1/box.
40R-100 Bulk. 100/box.



Mist Coolant

Specially formulated for all metals, including aluminum. Cools and lubricates, inhibits rust. Contains no nitrites.

270A Mist Coolant Unit. 1/box.

Hose Crimpers & Ferrules



855

■ Amflo Part No.

Standard Hose Crimper

Provides production capabilities and “big tool” crimping advantages at a much lower cost. Heavy duty ductile iron castings and hardened steel dies provide long service life and positive crimping. Includes five dies for crimping 1/4" braid to 3/8" double-braided hose. Also works on steel-braided hose.

855 1/box.



856

Replacement Dies for Hose Crimper

Sizes indicated (*) are included with Hose Crimper above. 1/bag.

856-1*	5/8"	(.6250)
856-2*	37/64"	(.5781)
856-3*	17/32"	(.5312)
856-4*	31/64"	(.4844)
856-5*	11/16"	(.6875)
856-8	3/4"	(.7500)
856-9	13/16"	(.8125)
856-10	3/8"	(.3750)

WARNING: The products on this page are designed for use on compressed air lines only. Select fitting to match hose diameter. Fittings must be secured with the proper size crimped-on ferrule. Do not exceed the pressure limitation of the hose and/or air operated devices being used. Failure to follow these directions exactly may cause fittings to separate from hose and may result in personal injury and/or property damage.

Hose Crimpers & Ferrules

■ Amflo Part No.

Brass Ferrules

Use with hose barb fittings. Make sure ferrule closely matches hose O.D.
For use with Amflo Hose Crimper 855 on previous page.

7321-50	.478" ID ferrule. 50/box.
7322-50	.500" ID ferrule. 50/box.
7322-100	.500" ID ferrule. 100/box.
7323-50	.525" ID ferrule. 50/box.
7323-100	.525" ID ferrule. 100/box.
7325-50	.562" ID ferrule. 50/box.
7325-100	.562" ID ferrule. 100/box.
7326-50	.593" ID ferrule. 50/box.
7326-100	.593" ID ferrule. 100/box.
7327-50	.625" ID ferrule. 50/box.
7327-100	.625" ID ferrule. 100/box.
7328-50	.656" ID ferrule. 50/box.
7328-100	.656" ID ferrule. 100/box.
7329-50	.687" ID ferrule. 50/box.
7329-100	.687" ID ferrule. 100/box.
7330-50	.718" ID ferrule. 50/box.
7330-100	.718" ID ferrule. 100/box.
7331-50	.750" ID ferrule. 50/box.
7331-100	.750" ID ferrule. 100/box.
7332-50	.781" ID ferrule. 50/box.
7333-50	.812" ID ferrule. 50/box.
7334-50	.825" ID ferrule. 50/box.
7335-50	.850" ID ferrule. 50/box.
3952-50	.875" ID ferrule. 50/box.
3952-100	.875" ID ferrule. 100/box.
5029A-50	.900" ID ferrule. 50/box.
7242A-50	.937" ID ferrule. 50/box.



7325



7329



7333



5029A

WARNING: The products on this page are designed for use on compressed air lines only. Select fitting to match hose diameter. Fittings must be secured with the proper size crimped-on ferrule. Do not exceed the pressure limitation of the hose and/or air operated devices being used. Failure to follow these directions exactly may cause fittings to separate from hose and may result in personal injury and/or property damage.

TRU-FLATE® Tire Repair Products

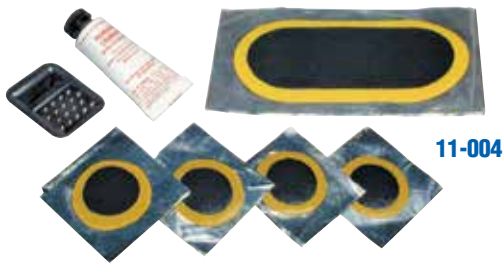

11-004

Cold Patches

Bicycle Tube Foil-Back Repair Kit

Handy kit easily fits in pocket. Contains foil backed patches, .25 oz. cement, abrasive paper and directions. Moisture resistant plastic case.

11-004 Carded. 10/master.

Chembond® Tube and Bias Patches

These world famous patches are available in 2 shapes and 6 sizes. Pure rubber flows into the injury. May be applied with Universal Cement or an electric vulcanizer.

Tube Tire Repair Kit. Contains patches, .30 oz. cement and buffer.

14-130 Carded. 5/master.

Chembond Refill Kit. Contains 5 each of 14-152 and 14-153.

14-131 Carded. 5/master.



14-130

14-154

14-159

Part No.	Quantity	Type	Size
14-152	40	Sm. Round	1-5/8"
14-153	30	Med. Round	2-1/4"
14-154	20	Lg. Round	3-1/8"
14-159	20	Lg. Oval	2-5/8" x 5-3/4"

Radial Patches

Used for nail hole injuries in auto and light truck tires. Heavier construction than Chembond patches. Utilize buffer cleaner and Universal Cement for a strong repair.

Radial Tire Repair Kit

For DIY radial repairs. Contains patches, .30 oz. cement and buffer.

14-132 Carded. 5/master.



14-132

14-140

Part No.	Quantity	Type	Size
14-137	30	Sm. Round	2-1/4"
14-139	20	Med. Round	3-1/4"
14-140	10	Lg. Round	4-1/8"

Foil-Backed Repair Units

Used for repairing tubes and tires where fabric reinforcement is not required. Repair units feature a foil backing that keeps the repair fresh. Conveniently packed. For best results, use with Camel® Cam-Cure® Cement.

Foil-Back Repair Kit. Contains patches, .30 oz. cement and buffer.

14-134 Carded. 5/master.

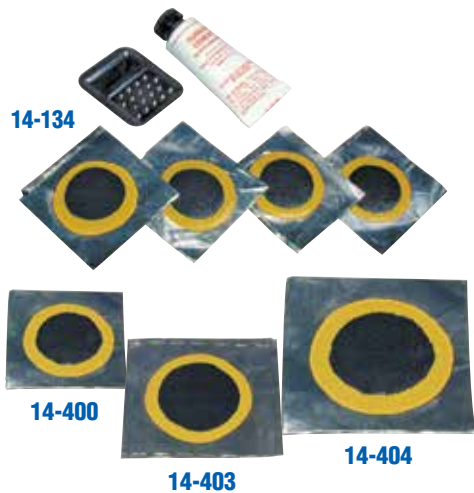

14-134

14-400

14-403

14-404

Part No.	Quantity	Type	Size
14-401	30	Round	1-1/2"
14-402	30	Round	1-3/4"
14-403	30	Round	2-1/8"
14-404	30	Round	3-1/8"

Tire Repair Kits

Super-Grip Emergency Tire Repair Kit

For all bias ply and non-speed rated radial tires. Contains Super-Grip probe, open-eye tool, .30 oz. cement and 5 radial inserts.

15-162 Carded. 5/master.

15-161 Refill Kit for 15-162. 10 strings. Carded. 5/master.

Emergency Repair Kit

For all bias ply and non-speed rated radial tires. Contains open-eye needle and probe screwdriver-type tools, 3 repair strings and .30 oz. cement.

15-163 Carded. 5/master.

15-164 Refill Kit for 15-163. Contains 5 refill strips and .30 fl. oz. Universal Cement. Carded. 5/master.

Emergency Repair Radial Tire Kit

This handy kit easily fits in the glove box of any car. Contains 10 repair strings and a closed-eye needle. Not for speed rated radial tires.

15-165 Carded. 5/master.

Perma-Strip® Patch Kit

Emergency repair kit for bias ply and non-steel belted radial tires. Contains 6 repair strips, .30 oz. cement and open-eye needle.

15-169 Carded. 5/master.

15-170 Refill Kit for the 15-169. Contains 12 repair strips, .30 oz. Universal Cement. Carded. 10/master.

Emergency Off-Road Tire Repair Kit

Comes in handy tool pouch. Contains 10 string repairs, open-eye tool, Super-Grip probe and .59 oz. cement.

15-262 Carded. 1/master.

Heavy Duty Truck Tire Emergency Repair Kit

Contains everything needed for emergency repairs on the largest truck tires – heavy duty all steel split-eye T-handle tools with Sheffield steel shaft, 8" spiral cement tool, 2 oz. Universal Cement and 15 heavy duty inserts. All packed in a heavy reclosable vinyl pouch.

15-282 Carded. 1/master.

Perma-Strip® Deluxe Patch Kit

An excellent kit for off-road applications such as ATVs and farm tires. Contains 50 strips, 8 oz. Universal Cement, open-eye needle and probe.

15-178 1/box.

Dealer Kit

Contains our most popular T-handle tools, 4 oz. Universal Cement and two boxes of 4" radial inserts. Box with reclosable lid keeps tools organized.

15-189 1/box.



WARNING: Keep tire repair kits away from children. Always use eye protection when working on tires. Do not attempt on-the-wheel repairs on tires inflated with a gas propelled tire sealant. Follow sealant manufacturer's directions for deflating tire and removing the tire from the rim. Have tire promptly repaired by the installation of a permanent patch. It is recommended that a trained repair person inspect the inside of the tire carefully for injury to ensure that the puncturing object did not cause further damage.

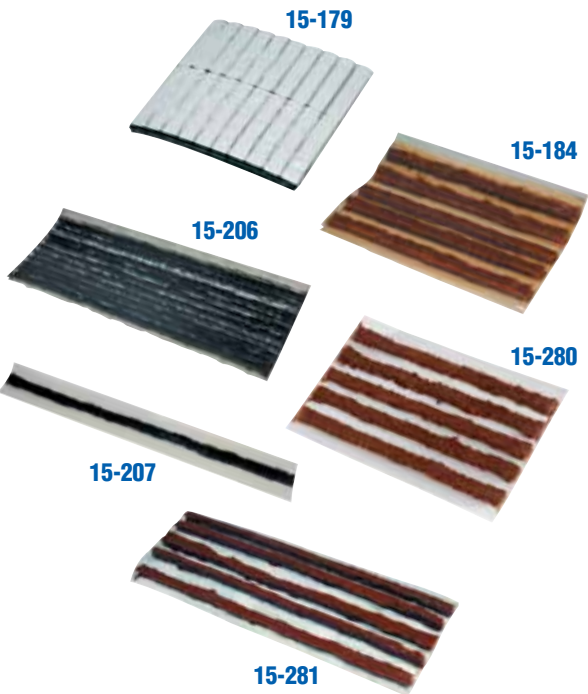

Inserts & String Repair

Perma Strip® Patch
For bias ply and non-steel belted radial tire repairs.
15-179 1/4" x 2". 50/box.

Radial Inserts
For most auto and light truck radial tire emergency repairs.
15-184 4" length. 20/box.
15-280 4" length. 60/box.

String Repairs
For bias ply and tubeless tire emergency repairs.
15-206 7" length. 50/box.

Heavy Duty String Repairs
For bias ply and radial tire nail hole emergency repairs.
15-207 7-1/2". 50/box.

Steel Belted Radial Truck Insert
Heavy duty inserts for emergency repairs of nail holes in truck tires.
15-281 7" length. 30/box.

Plug-N-Patch Repair Units

Designed specifically for speed rated radial and bias ply tires. Round molded rubber with built-in straight pin to repair nail and screw hole injuries on autos and/or trucks.

- 15-295 Small.** 1/8" stem size. Box of 48.
- 15-296 Medium.** 1/4" stem size. Box of 20.
- 15-297 Large.** 3/8" stem size. Box of 15.
- 15-298 Repair Kit.** Contains 1 small patch, 1 medium patch and .30 oz. cement. Carded. 5/master.
- 15-290 Small.** Reinforced. For up to 1/8" crown puncture. Box of 15.
- 15-291 Medium.** Reinforced. For up to 1/4" crown puncture. Box of 10.

Cement

Non-Flammable

- 12-077 Universal Cement.** 2 oz. tube. Carded. 5/master.
- 12-085 Universal Cement.** 1/4 pint (4 oz.) can. 24/master.
- 12-086 Universal Cement.** 1/2 pint (8 oz.) can. 6/master.
- 12-089 Universal Cement.** 1 quart can. 12/master.
- 12-087 Cam-Cure® Heavy Duty Cement.** Use with Cam-Cure repair units to ensure a permanent bond. 1/2 pint (8 oz.) can. 6/master.

Flammable

- 12-287 Cam-Cure® Flammable Cement.** For professional use. Chemical Vulcanizing. 1/2 pint (8 oz.) can. 24/master.

Chemicals & Sealants

Tire Bead Sealer

Prevents bead leaks and eases tire installation. Includes brush in cap.

12-090 1 quart can. 12/master.

Liquid Tire Buffer/Cleaner

Used to clean rubber so patches will adhere properly. Use prior to all power buffing. Nonflammable.

12-092 1 quart can. 12/master.

12-093 16 oz. aerosol can. 12/master.

"Stuf" Tire Mounting Lubricant with Rust Inhibitor

Stops rubber squeaks, easy to use and safe. Mixes with warm water.

12-095 8 lb. pail. 4/master.

12-096 40 lb. pail. 1/master.

Rubber Lubricant

Cleans and preserves tires, rubber parts, floor mats and vinyl tops.

12-097 1 gallon bottle. 4/master.



12-090

12-092

12-093



12-095

12-097

Reinforced Unitized Boots *(not for use on tubeless tires)*

Right angle cord construction uses high tensile cords for strength. Won't dry out or self-cure. May be used with cement or a spotter.

Part No.	Quantity	Type	Size	Ply
13-102	20/box	Nail Hole	3-1/4"	2
13-103	10/box	Small	4-1/2"	2
13-105	10/box	Medium	6"	2
13-106	10/box	Med. Large	7-3/8"	3
13-107	10/box	Large	8-3/4"	4
13-108	6/box	Truck	10-3/4"	5
13-123	2/bag	Nail Hole	3-3/16"	2
13-126	1/bag	Small	4-1/2"	2
13-127	1/bag	Medium	6"	2
13-128	1/bag	Med. Large	7-3/8"	3



Reinforced Unitized Boots

Repair Units

Part No.	Quantity	Size	Ply
Radial. For radial tires only. Has 4 centering lines and bead arrow.			
13-310	20	2-1/4" x 3"	1
13-312	10	2-3/4" x 4-1/2"	2
13-320	10	3" x 4-1/8"	2
13-322	10	3" x 6-3/4"	2
13-340	5	4" x 7-1/2"	3

Universal. For bias ply and radial tires. Use with Cam-Cure® cement.

13-451 30 2-1/2" 1

13-452 20 3-1/4" 1

Repair Kit. Contains 2 universal patches and .30 oz. cement.

13-230 Carded. 5/master.



Radial Repair Unit



Universal Repair Unit



Tire Repair Hand Tools

Open-Eye Repair Needle

15-172 Carded. 10/master.

Tire Repair Probe

15-174 Carded. 10/master.

Super-Grip Open-Eye Needle

15-224 Carded. 6/master.

15-944 Bulk. 175/box.

Super-Grip Tire Probe

15-225 Carded. 6/master.

Super-Grip Split-Eye Needle

15-227 Carded. 12/master.

Heavy Duty Truck Needle

15-231 Carded. 6/master.

15-230 Replacement Shaft for 15-231. 1/box.

Spiral-Grip Cement Needle

15-232 12/box.

Open-Eye Truck Tire Needle

15-249 8" length. 12/box.

Tire Marking Crayons

Tire Lettering Stick

Restores the white on hollow and raised letters on tires.

17-235 Carded. 5/master.

Yellow Tire Marking Crayon

17-236 Carded. 5/master.

17-253 12 packs of 12 crayons each (17-236). Bulk. 144/box.

Cotton Applicator Swab

17-295 Carded. 12/master.

Professional Stitchers

Ball Bearing Stitchers

With hardened steel wheel and varnished wooden handle.

17-244 1/16" face x 1-1/2" diameter. Carded. 6/master.

17-245 1/8" face x 1-1/2" diameter. 1/box.

17-246 1/4" face x 2" diameter. 1/box.

Combination Buffer/Stitcher

17-237 Carded. 10/master.

Buffing Cones

Heavy Duty Automotive Buffing Cone

18-259 2-1/2" diameter. Maximum 25,000 RPM. Carded. 1/bag.

Standard Automotive Buffing Cone

18-260 2" diameter. Maximum 25,000 RPM. Carded. 1/master.

Professional Air Buffers

Supreme High Speed Air Buffer

Light duty buffer for automotive tires and tubes. Maximum 10,000 RPM.

18-264 1/box.

Heavy Duty High Speed Air Buffer

Excellent for truck and tractor tire repairs. Maximum 16,000 RPM.

18-266 1/box.



18-264



18-266

Chrome Sleeve Snap-In Valves

Used for .453" diameter rim holes. Do not use on tires that exceed 65 PSI or on rims that exceed .156" thickness.

TR 413. 1-1/4" effective length.

30-136 4 pack. Carded. 10/master.

TR 418. 2" effective length.

30-186 4 pack. Carded. 10/master.



30-136



30-186



30-316

30-318

Chrome Sleeve and Nut Dress-Up Kits

Used to dress up rubber snap-in valves. Includes 4 sleeves and 4 nuts.

30-316-4 Fits TR413. 4 pack. Carded. 5/master.

30-318-4 Fits TR418. 4 pack. Carded. 5/master.

Snap-In Valves for .453 Rim Holes

Fits smaller wheel sizes like hand trucks, wheelbarrows, golf carts and other specialty vehicles with .453" diameter rim hole. Maximum 60 PSI.

TR 412. 7/8" effective length.

30-412-2 2 pack. Carded. 10/master.

30-412-50 Bulk. 50/box.

30-412-500 Bulk. 500/box.

TR 413. 1-1/4" effective length.

30-413-2 2 pack. Carded. 5/master.

30-413-10 10/box.

30-413-50 Bulk. 50/box.

30-413-500 Bulk. 500/box.

TR 414. 1-1/2" effective length.

30-414-2 2 pack. Carded. 5/master.

30-414-10 10/box.

30-414-50 Bulk. 50/box.

30-414-500 Bulk. 500/box.

TR 418. 2" effective length.

30-418-2 2 pack. Carded. 5/master.

30-418-10 10/box.

30-418-50 Bulk. 50/box.

30-418-500 Bulk. 500/box.

TR 423. 2-1/2" effective length.

30-423-4 4 pack. Carded. 5/master.

30-423-10 10/box.

30-423-50 Bulk. 50/box.

30-423-500 Bulk. 500/box.



30-412



30-413



30-414



30-418



30-423



Snap-In Valves for .625 Rim Holes

- TR 415.** 1-1/4" effective length.
30-415-2 2 pack. Carded. 5/master.
30-415-10 10/box.
30-415-50 Bulk. 50/box.
30-415-500 Bulk. 500/box.

- TR 425.** 2" effective length.
30-425-4 4 pack. Carded. 5/master.
30-425-10 10/box.
30-425-50 Bulk. 50/box.

High Pressure Snap-In Valves

Maximum 80 PSI. Includes core and cap. Fits .453" rim holes. Not for rims over .205" thick.

- TR 600HP.** 1.27" effective length.
30-600-10 10/box.
30-600-50 Bulk. 50/box.
30-600-500 Bulk. 500/box.

- TR 602HP.** 2" effective length.
30-602-50 Bulk. 50/box.

Tire Valves

- TR 430. Tubeless Clamp-In Motorcycle Valve**
 Fully threaded stem for use on many rim thicknesses. O-ring seal. 1-3/16" effective length. Fits .327" valve hole.
30-430-10 10/box.

- 599IB. High Performance Tire Valve**
 Chrome plated clamp-in valves are easily installed in all types of passenger car wheels with .453" or .625" valve holes.
30-445 Carded. 5/master.

- TR 416. Clamp-In Tubeless Tire Valves.** 1-1/4" effective length.
 Nickel plated metal valves for passenger cars, light trucks and industrial rims with .453" or .625" valve holes. Rubber grommet forms a seal when valve is clamped to rim. Maximum 130 PSI. Includes 2 rubber grommets.
30-463 Carded. 10/master.
30-463-50 Bulk. 50/box.
30-463-500 Bulk. 500/box.

- TR 416. Clamp-In Tubeless Tire Valve.** 2" effective length.
30-461-50 Bulk. 50/box.

- TR 417. Clamp-In Valve for Front Wheel Drive**
 Use on Cadillac El Dorado and Oldsmobile Toronado through 1978.
30-472-5 5/box.

- Tube Type Passenger Valves**
 Special compound cushion gum base allows bonding of valve to the tube using hot or cold (chemical bond). 1-3/8" effective length.
31-013-5 TR 13. Shank diameter .406". 5/box.
31-015-5 TR 15. Shank diameter .651". 5/box.

Tire Valves (cont.)

Rim Hole Bushing

Used to reduce the size of large rim holes so TR 13 valves fit more snugly.

31-336-100 Bulk. 100/box.



31-336-100

Straight Clamp-In Valves

For one-piece drop center rims with 5/8" diameter side-mount valve holes.

TR 500. 2" effective length.

32-200-10 10/box.

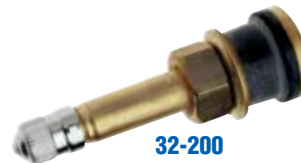

32-200

TR 570. 3-1/8" effective length.

32-201-10 10/box.

32-201-100 Bulk. 100/box.

32-985-10 Replacement grommet for TR 570 valves. 10/bag.



**32-201
32-202
32-203**

TR 571. 3-3/8" effective length.

32-202-10 10/box.

TR 572. 3-3/4" effective length.

32-203-10 10/box.

32-203-100 Bulk. 100/box.

32-203-250 Bulk. 250/box.

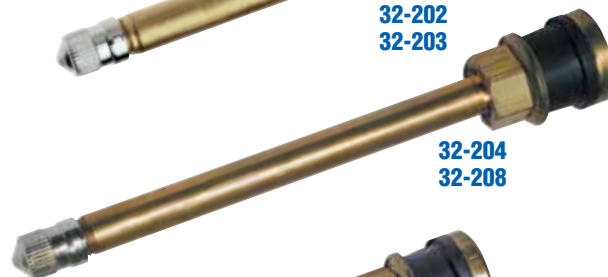

**32-204
32-208**

TR 573. 4-3/8" effective length.

32-204-10 10/box.

32-204-100 Bulk. 100/box.

32-204-250 Bulk. 250/box.



**32-205
32-207**

TR 501. 1-1/2" effective length.

32-205-10 10/box.

TR 575. 1-1/8" effective length.

32-207-10 10/box.

TR 574. 5" effective length.

32-208-50 Bulk. 50/box.

32-208-250 Bulk. 250/box.



**32-543-10
32-547-10**

Truck Tubeless Valves

Fits 9.7 mm (.382") rim holes. Rubber O-ring forms a seal when valve is clamped to rim. Designed specifically for aluminum wheels. 60° bend.

32-543-10 TR 543D. 2.31" effective length. 10/box.

32-547-10 TR 545D. 3.5" effective length. 10/box.



32-608-10

Import Truck Tubeless Valves (ETRO)

Used on Volvo, Mac and Iveco imported trucks. Fits 9.7 mm (.382") rim holes. Includes O-ring, nut, core and cap. 27° bend.

32-608-10 ETRO V3-20-4. 10/box.

Tubeless Tractor Valve

Has removable core housing. Complete with core housing, valve core, cap, hex nut, washer and rubber grommet.

34-221-5 TR 618A. 1-7/8" effective length. 5/box.



34-221-5

Air-Liquid Core Housing

Screws into air-liquid valves and extensions. Features O-ring seal.

34-963-10 TR CH-3. 10/box.

34-282-25 Nylon rim nut used with air-liquid tire valves. 25/box.



34-963-10



34-282-25

34-955



38-313



38-314



38-315



38-324

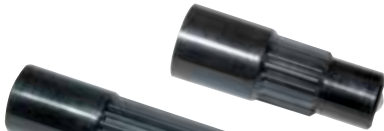

38-325
38-326



38-400



38-430

38-432 38-476
38-436 38-477
38-472 38-478



38-483



Tire Valves (cont.)

Fluid Adapter Set

Permits fast filling of tires for ballast. Fits all standard bore air/water valves. Includes extra bushings for standard (.305"-32) and old-style (.406"-26) valves. Button valve on side releases air displaced by fluid.

34-955 1/bag.

Valve Adapters. Convert large bore valves to standard bore.

37-080 Uses outer valve threads. 5/box.

37-096 Uses inner valve threads. 5/box.

Valve Extensions

Double Sealing Extension. Has 2 O-rings for high pressure applications.

38-313-50 Bulk. 50/box.

38-313-250 Bulk. 250/box.

38-313-1000 Bulk. 1000/box.

Chrome Plated Brass Extension. 3/4" effective length.

38-314-4 4 pack. Carded. 5/master.

38-314-50 Bulk. 50/box.

Chrome Plated Brass Extension. 1-1/4" effective length.

38-315-4 4 pack. Carded. 5/master.

38-315-50 Bulk. 50/box.

Black Nylon Extension. 3/4" effective length.

38-324-4 4 pack. Carded. 5/master.

38-324-50 Bulk. 50/box.

Black Nylon Extension. 1-1/4" effective length.

38-325-4 4 pack. Carded. 5/master.

38-325-50 Bulk. 50/box.

Black Plastic Extension. 1-1/2" effective length.

38-326-4 4 pack. Carded. 5/master.

38-326-50 Bulk. 50/box.

Dual Wheel Valve Extension. 7" effective length.

Provides easy access to inner dual wheels on motor homes and other vehicles with small dual wheels. Includes clamp to secure hose to wheel.

38-400 Carded. 2/master.

Standard Truck Extensions

Screws onto standard valve cap to make mouth more accessible for service.

38-430-10 3-1/16" effective length. 10/box.

38-432-10 6-1/16" effective length. 10/box.

38-436-10 5-1/16" effective length. 10/box.

38-472-10 1-3/8" effective length. 10/box.

38-476-10 2-7/32" effective length. 10/box.

38-477-10 3-1/8" effective length. 10/box.

38-478-10 4-1/8" effective length. 10/box.

Bent Metal Extension

38-483-10 1-1/2" effective length. 90° angle. 10/box.

Valve Caps

Plastic Valve Cap - VC8

Black flexible plastic cap (has no sealing unit).

38-505 4 pack. Carded. 5/master.

38-505-100 Bulk. 100/box.

38-505-500 Bulk. 500/box.

Nitrogen Valve Caps

Green plastic caps with seal

38-510 4 pack. Carded. 5/master.

38-510-100 Bulk. 100/box.

Screwdriver Valve Cap - VC2

All-purpose cap with screwdriver top for removing and inserting valve cores.

Fits .305"-32 threads on standard type valves.

38-600-4 4 pack. Carded. 5/master.

38-600-100 Bulk. 100/box.

Standard Valve Cap - VC3

Dome-shaped top and guide on skirt for easy application to valve threads.

38-772-4 4 pack. Carded. 5/master.

38-772-100 Bulk. 100/box.

38-772B-1000 Same as 38-772 but with black finish. Bulk. 1000/box.

Heavy Duty Valve Caps

For use on chrome sleeve and high performance valves. Heat resistant.

38-712-4 4 pack. Carded. 5/master.

38-712-100 Bulk. 100/box.

Heavy duty cap with special heat resistant rubber washer. Has guide on skirt for wasy application to valve threads. 0-250 PSI. -40-200 degree operating temperature. Nickel plated

38-750-100 Bulk. 100/box.

Hex-Shaped Valve Cap

Made from hexagon rod for wrench application. Special sealing washer for high pressure use. Conforms to Military Spec. MIL-C-5000 and MS-20813.

38-714-100 Bulk. 100/box.

Valve Cores

Standard Valve Core

Recommended for truck, bus and commercial applications. All have .206"-36 threads and are compatible with existing USA, ETRTO and ISO standards.

Meets specifications ZZ-V-25 and TR C-1.

38-790-4 4 pack. Carded. 5/master.

38-790-100 Bulk. 100/box.

38-790-1000 Bulk. 1000/box.

Aircraft Shock Strut Valve Core

Meets specifications AN-809-1 and MIL-C-5499. Maximum 2000 PSI.

0-165° F operating temperature. 100 PSI opening pressure.

38-805-100 Bulk. 100/box.

Hydraulic Accumulator Valve Core

Meets specifications AN-809-1 and MIL-C-5499. Maximum 2000 PSI.

0-165° F operating temperature. 70 PSI opening pressure.

38-810-100 Bulk. 100/box.



38-505



38-510



38-600



38-712



38-772



38-714



38-750



38-790



38-805



38-810



38-825

Tire Repair Products



■ Tru-Flate Part No.

■ Amflo Part No.

Valve Cores (cont.)

General Purpose Valve Core

Meets specifications ZZ-V-25 and TR C-1. Maximum 200 PSI. -40–225° F operating temperature. 60 PSI opening pressure.

38-830-100 Bulk. 100/box.

Airplane Valve Core

For high pressure, heat-resisting applications. Meets specifications MIL-V-27317 and TR C-4. Maximum 400 PSI. -65–350° F operating temperature. 70 PSI opening pressure.

38-825-100 Bulk. 100/box.

Large Bore Valve Core

Has .305"-32 threads and is compatible with existing USA standards for large bore valve housings. Meets specification TR C-2. 0–200 PSI.

38-828-10 10/box.

Tire Service Tools

Tread Depth Gauge

Steel indicator bar. Calibrated from 0 – 1" in 1/32" increments. Includes handy pocket clip.

40-395 Carded. 5/master.

40-395-100 Bulk. 100/box.

4-Way Tire Valve Repair Tool

Repairs core and stem threads. Has core screwdriver and broken core extractor. Sturdy all metal construction.

41-067 Carded. 5/master.

41-067-20 20/box.

Double-Use Tool

For deflating tire tubes and core removal.

41-068 Carded. 10/master.

Valve Core Extracting Tool

Simplifies removal of old cores that are difficult to unscrew.

41-444 Carded. 10/master.

Valve Fishing Tool

Centers valve in rim hole while mounting tires. For use on .453" and .625" rim holes.

41-466 Carded. 5/master.

Valve Core Extracting Tool

Heavy duty all metal construction.

41-469 Carded. 10/master.

Tubeless Tire Valve Inserting Tool

Used for installation and removal of rubber snap-in valves.

41-506 Carded. 5/master.

41-506-5 5/box.

Valve Cap & Core Remover

Grip and holds core bridge and cap to provide means of inserting cores in hard-to-reach valves.

8769A 1/box.

**PLEWS &
EDELMAANN**

Amflo[®]

Camel[®]

EDELMAANN[®]

LubriMatic[®]



PLEWS[®]
LubriMatic

POWERCRAFT[®]

TRU-FLATE[®]

UltraLUBE[®]

Amflo:

Air Line Accessories
Pneumatic Hoses & Reels

Camel:

Tire Repair

Edelmann:

Automotive Fittings
Brake Lines
Engine Oil Cooler Lines
Power Steering Hoses & Repair Kits

LubriMatic:

Oils, Greases & Spray Lubricants

Omega:

Power Steering Hoses & Repair Kits

Plews/LubriMatic:

Lubrication Equipment

Powercraft:

Power Steering Hoses & Repair Kits

Tru-Flate:

Air Line Accessories
Tire Gauges & Tire Hardware

UltraLube:

Biobased Lubricants

Amflo[®] and **TRU-FLATE[®]**

Professionals and DIYers everywhere rely on the quality of Amflo[®], Camel[®] and Tru-Flate[®] tire gauges, blow guns, tire hardware & air line hoses, reels, chucks, couplers, plugs, regulators, tire repair and tire hardware. Part of the Plews & Edelmann family of products, Amflo, Camel and Tru-Flate serve the industrial, hardware, marine, automotive and agricultural markets, as well as many industries requiring professional grade air line and tire products.



1550 Franklin Grove Rd.
Dixon, IL 61021 USA
Telephone: 800-770-4639
Fax: 815-288-3388
plews-edelmann.com

 **PLEWS &
EDELMA**

The leader in quality air line & tire products